

LA BLINDATA FILO MURO WALL FLUSH SECURITY DOOR

WALL SECURITY



wall secu rity

FORTE COME UN MURO, FLESSIBILE COME UNA DIERRE.
A WALL SECURITY PUOI CHIEDERE TUTTO. L’AFFIDABILITÀ DI UNA BLINDATA,
L’ELEGANZA DI CERNIERE INVISIBILI, IL RESPIRO DI UN’APERTURA A 180°,
L’ADATTABILITÀ A TUTTE LE CHIUSURE DI SICUREZZA. WALL SECURITY:
DENTRO UN MURO DI ACCIAIO, FUORI LO STILE DI CASA TUA.

Flexible as any Dierre door but as strong as a wall. Wall Security can be asked anything.

The reliability of a security door, the elegance of hidden hinges,
the 180° wide opening and adaptability to all security closure systems.

Wall Security: a steel wall inside, your home style outside.



2

4

6

5

1 CERNIERE COMPLETAMENTE NASCOSTE
Fully hidden hinges

2 PERFETTAMENTE PLANARE
Perfectly flat

3 GUARNIZIONI DI FINITURA IN ACCIAIO
VERNICIATO GRIGIO ARGENTO
Silver grey varnished steel finishing seals

4 PROFILO IN ALLUMINIO
ANODIZZATO ARGENTO
Profile in silver
anodized aluminium

5 GUARNIZIONE ESTETICA
DI COLORE NERO
Black aesthetic seal

6 PROFILO TOP SECRET
Top Secret profile



3

1



IL DESIGN È UNA SCIENZA CON UN'ESTETICA, UN'ARTE ALL'INTERNO DI UN'INDUSTRIA. È UNA LINEA SOTTILE TRA TECNOLOGIA E BELLEZZA. PROPRIO SU QUELLA LINEA SI MUOVE IL CENTRO STILE DIERRE, UN LABORATORIO INTERNAZIONALE APERTO SUL MONDO E SULLE SUE SUGGERZIONI. QUI L'ISPIRAZIONE PRENDE FORMA GRAZIE A UN TEAM DI PROGETTISTI E ARCHITETTI RICETTIVI E INTUITIVI. È ACCADUTO IERI CON FUSION E MIMESI, LE INNOVATIVE PORTE FILOMURO PER INTERNI A MISURA DI INTIMITÀ, ACCADE OGGI CON WALL SECURITY, LA PRIMA PORTA BLINDATA FILOMURO.

Design means science combined to aesthetics, an art within an industry. It is a fine line between technology and beauty. And it's on that line that Dierre Style Centre interacts, an international laboratory open onto the world and its suggestions. Here inspiration takes shape thanks to a team of bright and intuitive designers and architects. It happened in the past with Fusion and Mimesi, the innovative interior doors flush to the wall to provide the utmost intimacy, it's happening at present with WallSecurity, the first security door flush to the wall.

new secret secret

WALL SECURITY. SICUREZZA INVISIBILE, STILE INTATTO.

Wall Security. Invisible security, intact style.

Perfettamente lineare rispetto alle mura di casa, in totale armonia con le vostre esigenze, Wall Security è la prima blindata filomuro Dierre.

Nata dalle intuizioni del centro stile Dierre, Wall Security è disponibile con diversi sistemi di chiusura, dalla più tradizionale doppia mappa e cilindro di servizio al cilindro di alta sicurezza, fino alla serratura completamente elettronica. La massima possibilità di personalizzazione è garantita inoltre da tre soluzioni di posa - standard, con kit Secret o con kit Top Secret.

La gamma Wall Security trova pieno completamento oggi con la nuova versione a doppio battente a spingere, con le versioni un battente a tirare e con le varianti Tagliafuoco EI₂ 30. Disponibile anche con ampie finestrate e arricchita da elementi sopra luce (solo per versioni a un battente), Wall Security Dierre è un progetto in continua evoluzione, la continua ricerca delle migliori soluzioni per la massima adattabilità e flessibilità.

Scopri il mondo Wall Security e le sue infinite personalizzazioni a pag. 64

Fully responding to your needs, perfectly flush to the house walls, Wall Security is the first Dierre armoured door flush to the wall.

Born from the intuitions of Dierre Style Centre, Wall Security is available with different locking systems, from the most traditional double bit and service cylinder to the high security cylinder, up to the fully electronic lock. The utmost customization possibility is also guaranteed thanks to three fitting solutions - standard, with Secret kit or with Top Secret kit. The Wall Security range has been presently fully completed with the new double leaf push version, with the single leaf pull versions and with the EI₂ 30 fire-rated variants. Also available with spacious glazing and enriched by overhead doorlight elements (for single leaf versions only), Wall Security Dierre is an ongoing project, with a continuous search for the best solutions for maximum adaptability and flexibility. Discover the Wall Security world and its countless customizations on page 64

wall
secu
rity

bi

elettra



bi
ele
ttra



WALL SECURITY BI-ELETTRA DETECTOR (BED) CON RIVESTIMENTO IN ABS SUPERLUX EBANO M040
(DISPONIBILE ANCHE CON KIT TOP SECRET O SECRET)

Wall Security Bi-Elettra Detector (BED) with abs superlux ebony M040 panelling
(Available also with the Top Secret or Secret kits)



bi
ele
ttra



WALL SECURITY BI-ELETTRA DETECTOR (BED) VERSIONE DOPPIO BATTENTE RIVESTIMENTO LACCATO GRIGIO RAL 1013
FINITURE TESTA DI MORO (DISPONIBILE ANCHE CON KIT TOP SECRET O SECRET)

Wall Security Bi-Elettra Detector (BED) double leaf version, grey RAL 1013 lacquered panelling with dark brown finishes
(Available also with Top Secret or Secret kits)

bi
ele
ttra



TECNOLOGIA, SICUREZZA LINEARE PER UNA PERFETTA INTESA CON LA PORTA DI CASA.

Technology, linear security for
the perfect harmony with the home door.

Una porta unica al mondo. Innovazione tecnologica declinata secondo le tendenze del design. Funzionale, semplice e sicura. Bi-Elettra Detector è una porta governata da un sistema elettronico automatico e di alta tecnologia. Questo innovativo sistema di sicurezza non prevede l'impiego di chiavi ma permette un controllo attivo degli accessi di casa, grazie ad un microchip che invia un segnale alla porta. Ogni microchip è dotato di un codice unico, scelto tra milioni di miliardi di combinazioni e non clonabile che permette a Bi-Elettra Detector di riconoscere ogni singolo accesso. Per aprire Bi-Elettra Detector è sufficiente avvicinare al display la chiave elettronica Keycard, una card con microchip incorporato delle dimensioni di una normale carta di credito. Oltre alla soluzione card, Bi-Elettra Detector si attiva anche con il Door Pass dalla sagoma di un telecomando e utilizzabile come portachiavi. Un sistema di alta tecnologia consente al Door Pass di inviare un segnale alla porta: basterà averlo in tasca e avvicinarsi per vedere la porta aprirsi. Un concetto assimilabile al telepass autostradale. La chiave denominata come "padronale" può gestire tutte le funzioni elettroniche del sistema come memorizzare nuove chiavi, abilitare o disabilitare l'accesso, cancellare le chiavi in caso di smarrimento o furto. In caso di lettura di chiavi non abilitate, Bi-Elettra Detector blocca ogni accesso agli utenti indesiderati. Inoltre lo stesso codice di una chiave elettronica può essere memorizzato su più porte estendendo così la gestione alla porta dell'ufficio, di una seconda abitazione etc. Il tutto all'insegna della massima sicurezza e comodità.

Unique in its kind. Technological innovation adapted following design trends. Secure, simple and functional. An automatic and hi-tech electronic system governs Bi-Elettra Detector. No keys are required by this innovative security system and an active control of accesses in the house is though enabled thanks to a microchip that sends a signal to the door. A unique code - chosen amongst millions of billions of possible combinations - features each microchip which cannot be cloned and allows Bi-Elettra Detector to detect each single access. Keycard, the electronic key being a card having an incorporated microchip, must simply be drawn close to the display to open Elettra. Door Pass, shaped as a remote control and that can be used as a key holder, also activates Bi-Elettra Detector in addition to the card option. A high tech system allows Door Pass to send a signal to the door: the door will open simply keeping it in one's pocket and standing close to it. A similar concept to that of the electronic motorway toll payment system. All the electronic features of the system can be managed through the "master" key, such as memorising new keys, enabling or disabling the access, cancelling the keys in case of loss or theft. In the event an unauthorized key is read, Bi-Elettra Detector would block the access to unwanted users. Furthermore the same code of an electronic key can be memorised on several doors thus extending the management of the office door, a second home, etc.. All with the utmost security and comfort.



SISTEMI DI APERTURA Opening systems

KEYCARD



Pratica, dalle dimensioni di una carta di credito, apre in modo automatico e veloce Bi-Elettra.

Practical, credit card-sized, automatically and quickly opens Bi-Elettra.

JACK KEY



Elegante e pratica come la chiave di una vettura, apre in modo automatico o tradizionale a seconda delle esigenze.

Elegant and functional as a car key, works automatically or as any other key depending on the needs.



WALL SECURITY
BI-ELETTRA DETECTOR (BED)
CON RIVESTIMENTO
INTERNO NEW
MELAMINICO GRAFITO GRIS.
(DISPONIBILE ANCHE CON
TOP SECRET O SECRET).

Wall Security Bi-Elettra
Detector (BED) with new
Melaminico Grafito Gris
internal
panelling (Available also with
Top Secret or Secret kits)

KEY CONTROL



Può essere utilizzato in alternativa a KEY CARD
come comodo e funzionale porta chiavi.

Can be used as an alternative to KEY CARD,
practical
because it can be a functional key holder.

DOOR PASS



Apertura automatica a distanza, basta avvicinarsi ad un metro
dalla porta perchè lei si apra.

Remote automatic opening, just draw a meter close
to the door for it to open.

MOSTRINA ESTERNA BI-ELETTRA DETECTOR Bi-Elettra Detector external escutcheon	MOSTRINA INTERNA BI-ELETTRA DETECTOR Bi-Elettra Detector internal escutcheon
 <p>The external escutcheon features a silver-colored frame and a black central panel. At the top, a blue LCD display shows the date and time: "30 nov. 19:20". Below the display, the brand name "Dierre" is printed. At the bottom, there is a sensor area with two small blue LEDs.</p>	 <p>The internal escutcheon has a similar design to the external one. Its blue LCD display shows the word "Apertura" (Opening) and the "Dierre" logo. Below the display, there is a control panel with a central circular button and several smaller buttons. At the bottom, there is a sensor area with two small blue LEDs.</p>

Modello Detector: il display a cristalli liquidi consente la visualizzazione del menù interattivo, attraverso il quale potrete impostare facilmente le molte funzioni. Bi-Elettra Detector è oggi disponibile nella versione “luci di cortesia”: la mostrina emette un fascio di luce che, illuminando la soglia, consente l’entrata e l’uscita comodamente anche in caso di scarsa illuminazione all’interno dell’abitazione.

Detector Model: the liquid crystal display allows viewing of the interactive menu through which many functions can be set. Bi-Elettra Detector is now available with the “courtesy light function”: the escutcheon produces a beam of light that, by lighting up the threshold, allows a comfortable entrance and exit even in case of scarce presence of light within the house.



FINITURE DI STILE Stylish finishes

<p>BIANCO White</p>	<p>NERO Black</p>	<p>BRONZO Bronze</p>
		
<p>ARGENTO (DI SERIE) Silver (Standard)</p>	<p>CROMO SATINATO Satin chrome</p>	<p>CROMO LUCIDO Polished chrome</p>
		
<p>OTTONE Brass</p>	<p>OTTONE RESISTA Resista brass</p>	
		

1 PULSANTE “CAMPANELLO”
“Buzzer” pushbutton



wall
secu
rity

se

ntry

se
nt
ry



WALL SECURITY SENTRY 1 (S1) RIVESTIMENTO METAL LINE FINITO TESSUTO
(DISPONIBILE ANCHE CON KIT TOP SECRET O SECRET)

Wall Security Sentry 1 (S1) imitation fabric Metal Line panelling (available also with Top Secret or Secret kits)



se
nt
ry



WALL SECURITY SENTRY 1 (S1) VERSIONE DOPPIO BATTENTE RIVESTIMENTO LACCATO ROSSO RUBINO RAL 3003
(DISPONIBILE ANCHE CON KIT TOP SECRET O SECRET)

Wall Security SENTRY 1 (S1) double leaf version, ruby red RAL 3003 lacquered panelling
(Available also with Top Secret or Secret kits)



L'ESPRESSIONE PIÙ AVANZATA DELLA SICUREZZA.

The most advanced expression of security.

Pratica e versatile con in più la sicurezza e la tranquillità della chiusura a cilindro di alta sicurezza, Wall Security Sentry di Dierre è una linea di porte in grado di diventare la perfetta sintesi dei vostri desideri. Grazie alle diverse tipologie di personalizzazione le porte Sentry si adattano a ogni ambiente, mantenendo sempre il massimo rispetto per il vostro stile personale. Carattere, forza e robustezza, perché la porta non è solo un complemento d'arredo, ma anche il primo segno distintivo della vostra casa.

Wall Security Sentry è disponibile nelle seguenti versioni:

- Sentry 1, con un'unica serratura a cilindro.
- Sentry 4, con un'unica serratura e due chiavi: la principale a cilindro di alta sicurezza, quella di servizio a cilindro.
- Sentry Double, con un'unica serratura e due chiavi: la principale a doppio cilindro di alta sicurezza, quella di servizio a cilindro.

A richiesta per ogni cilindro, una chiave da cantiere. Contenuta in un sacchetto contrassegnato da un'etichetta di colore rosso, la chiave da cantiere risulta pratica e comoda per tutte quelle situazioni non ancora definitive in cui si ha la necessità di aprire e chiudere la porta (ad esempio, durante i lavori di costruzione e ristrutturazione dell'abitazione). Al momento dell'acquisto dello stabile, al proprietario verrà consegnata la chiave definita padronale che, una volta inserita nel cilindro, verrà da esso riconosciuta come unica e definitiva. Da quel momento in avanti, sarà la sola chiave in grado di aprire la porta.

Practical and versatile with the further security and peace of mind of the high security cylinder locking system, Dierre Wall Security Sentry is a line of doors able to become the perfect synthesis of your wishes. Thanks to the different customization options the Sentry doors adapt to any environment, always perfectly blending-in with your personal style. Character, power and strength, for the door not to be a simple furnishing item, but also the first distinctive sign of your home. Wall Security Sentry is available in the following versions:

- Sentry 1, with a single cylinder lock.
- Sentry 4, with a single lock and two keys: high security cylinder for the main one, cylinder for the service lock.
- Sentry Double, with a single lock and two keys: high security double cylinder for the main one, cylinder for the service lock.

A master key on request per each cylinder. Contained in a bag marked by a red label, the master key is practical and convenient for all those not yet defined situations where opening and locking the door is required (for example during building works and renovation of the house). When purchasing the building, the owner will be delivered the final owner's key that, once inserted in the cylinder, will be recognised as unique and final. From that moment onward it will be the only key enabled to open the door.

se
nt
ry



DISPONIBILE ANCHE
IN VERSIONE
TAGLIAFUOCO EI₂30
Available also in the
fire-rated version EI₂30



SISTEMI DI APERTURA Opening systems

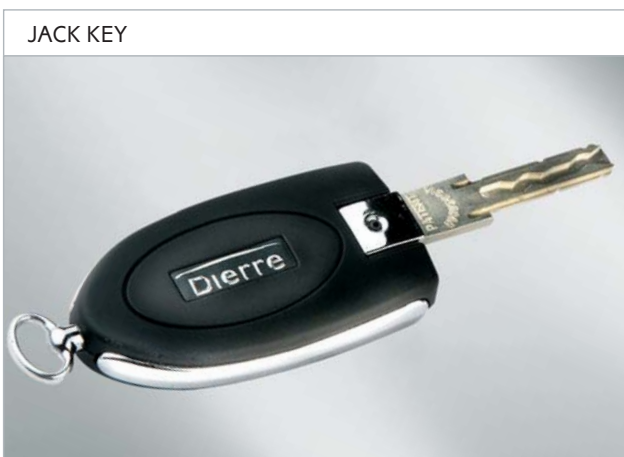

Chiave per cilindro New Power.
Key for New Power cylinder.

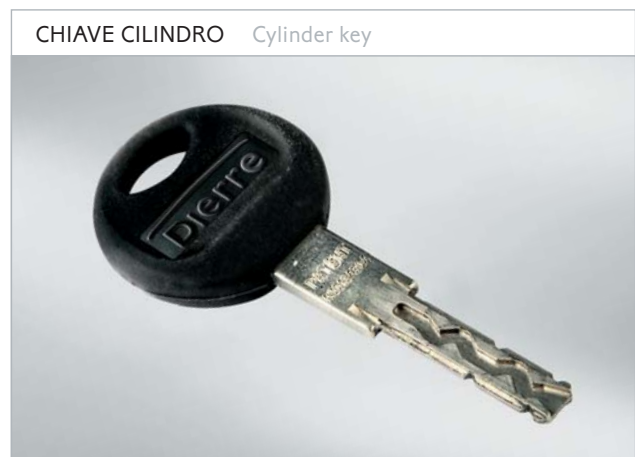

Chiave per cilindro New Power.
Key for New Power cylinder.



WALL SECURITY SENTRY 1 (S1) CON RIVESTIMENTO METAL LINE RAMATO (DISPONIBILE ANCHE CON KIT TOP SECRET O SECRET)

Wall Security Sentry 1 (S1) with Metal Line coppery panelling (Available also with Top Secret or Secret kits)

CILINDRO Cylinder



Cilindro New Power chiave/pomolo e chiave/chave.

New Power cylinder key/knob and key/key.

CHIAVE DA CANTIERE Master key



MOSTRINE Escutcheons

SENTRY 1 - SENTRY 1 DB



Lato interno
Internal side



Lato esterno
External side



Lato interno
Internal side



Lato esterno
External side

SENTRY 4 - SENTRY 4 DB



Lato interno
Internal side



Lato esterno
External side



Lato interno
Internal side



Lato esterno
External side

SENTRY DOUBLE - SENTRY DOUBLE DB



Lato interno
Internal side



Lato esterno
External side



Lato interno
Internal side



Lato esterno
External side

PARTICOLARI Details

SENTRY 1









SENTRY 4



SENTRY DOUBLE



FINITURE DI STILE Stylish finishes

<p>BIANCO White</p>	<p>NERO Black</p>	<p>BRONZO Bronze</p>
		
<p>ARGENTO (DI SERIE) Silver (Standard)</p>	<p>CROMO SATINATO Satin chrome</p>	<p>CROMO LUCIDO Polished chrome</p>
		
<p>OTTONE Brass</p>	<p>OTTONE RESISTA Resista brass</p>	
		



wall
secu
rity

hi-fi



WALL SECURITY HI-FI (HF) VERSIONE DOPPIO BATTENTE CON RIVESTIMENTO LACCATO RAL 8017
(DISPONIBILE ANCHE CON KIT TOP SECRET O SECRET)

Wall Security HI-FI (HF) double leaf version, with panelling lacquered RAL 8017
(Available also with Top Secret or Secret kits)



hi
fi



DISPONIBILE ANCHE
IN VERSIONE
TAGLIAFUOCO EI₂30
Available also in the
fire-rated version EI₂30

APERTURA A 180°, FUNZIONALITÀ A 360°.

180° opening, 360° functionality.

Wall Security HI-FI è sicurezza double-face grazie a due collaudati sistemi di chiusura in una sola serratura: a doppia mappa o a cilindro. Inoltre, il battente ha un corpo in acciaio, una scocca, al cui interno sono fissati speciali rinforzi verticali, per consentire la massima resistenza e rigidità all'intera struttura.

Le porte della linea Wall Security HI-FI sono pensate per darvi tutta la tranquillità che avete sempre desiderato. Ma la sicurezza non è tutto. Stile e design le rendono un vero elemento d'arredo, capace di adattarsi ad ogni vostro look.

Wall Security HI-FI saprà accompagnare ogni vostra preferenza con gusto, senza mai negarvi la massima solidità.

Wall Security HI-FI represents a twofold security thanks to two tested closure systems in a single lock: double bit or cylinder.

Furthermore, the steel body leaf contains special vertical reinforcements to allow the utmost strength and stiffness to the whole structure.

The Wall Security HI-FI line of doors are designed to provide you with all the peace of mind that you have always wished for. Security is not all though.

Style and design makes them a true furnishing element, able to adapt to any environment. Wall Security HI-FI will tastefully match your choices, without ever denying maximum strength.



SISTEMI DI APERTURA Opening systems

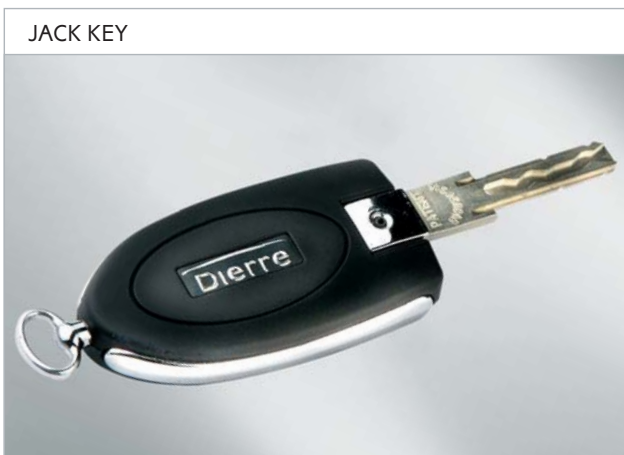

Chiave per cilindro New Power.
Key for New Power cylinder.

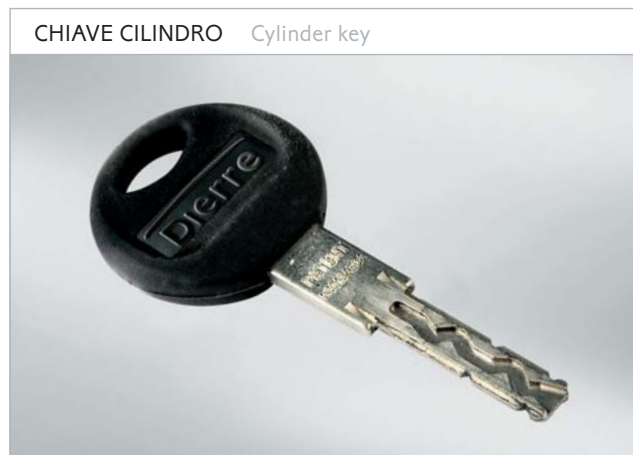

Chiave per cilindro New Power.
Key for New Power cylinder.



WALL SECURITY HI-FI (HF)
CON RIVESTIMENTO LISCIO
LACCATO RAL 6017
(DISPONIBILE ANCHE CON KIT
TOP SECRET O SECRET)

Wall Security HI-FI (HF)
with smooth panelling
lacquered ral 6017
(Available also with
Top Secret or Secret kits)



POD-KEY



Chiave a scatto per serratura doppia mappa.

Flip-open key for double bit lock.

NEW COLORKEY



Chiave per serratura doppia mappa.

Key for double bit lock.

MOSTRINE Escutcheons

HI-FI - HI-FI DB



Lato interno
Internal side

Lato esterno
External side

Lato interno
Internal side

Lato esterno
External side

DETTAGLIO SERRATURA Lock detail



FINITURE DI STILE Stylish finishes

<p>BIANCO White</p>  A white door handle and lock set. The handle is vertical with a rounded top and a keyhole at the bottom. The lock is circular with a keyhole in the center. Both are finished in a matte white.
<p>NERO Black</p>  A black door handle and lock set. The handle is vertical with a rounded top and a keyhole at the bottom. The lock is circular with a keyhole in the center. Both are finished in a glossy black.
<p>BRONZO Bronze</p>  A bronze door handle and lock set. The handle is vertical with a rounded top and a keyhole at the bottom. The lock is circular with a keyhole in the center. Both are finished in a polished bronze.
<p>ARGENTO (DI SERIE) Silver (Standard)</p>  A silver door handle and lock set. The handle is vertical with a rounded top and a keyhole at the bottom. The lock is circular with a keyhole in the center. Both are finished in a standard silver.
<p>CROMO SATINATO Satin chrome</p>  A satin chrome door handle and lock set. The handle is vertical with a rounded top and a keyhole at the bottom. The lock is circular with a keyhole in the center. Both are finished in a brushed satin chrome.
<p>CROMO LUCIDO Polished chrome</p>  A polished chrome door handle and lock set. The handle is vertical with a rounded top and a keyhole at the bottom. The lock is circular with a keyhole in the center. Both are finished in a highly reflective polished chrome.
<p>OTTONE Brass</p>  A brass door handle and lock set. The handle is vertical with a rounded top and a keyhole at the bottom. The lock is circular with a keyhole in the center. Both are finished in a polished brass.
<p>OTTONE RESISTA Resista brass</p>  A resista brass door handle and lock set. The handle is vertical with a rounded top and a keyhole at the bottom. The lock is circular with a keyhole in the center. Both are finished in a polished resista brass.



wall
secu
rity at

at



WALL SECURITY AT 3 CON RIVESTIMENTO ROVERE TINTO WENGÈ E INSERTI IN CROMO SATINATO
(DISPONIBILE ANCHE CON KIT TOP SECRET O SECRET)

Wall Security AT 3 with wenge stained oak and satin chrome inserts
(Available also with Top Secret or Secret kits)



FORZA MAI INVADENTE.

Never intrusive strength.

Discreta, minimale, aperta a infinite personalizzazioni, Wall Security AT è design intelligente capace di proteggerti dai tentativi di effrazione. Dotata di uno dei più tradizionali ed efficaci sistemi di chiusura, Wall Security AT protegge i vostri spazi. Dierre ne aumenta il livello di sicurezza grazie alla forza di una piastra antitrapano e antieffrazione in acciaio che protegge la serratura dai tentativi di scasso e al blocchetto intercambiabile Mia, che consente, in caso di furto, perdita o sospetta copiatura delle chiavi, infinite sostituzioni della chiave senza cambiare l'intera serratura. Con la sua serratura unica a doppia mappa AT è la più classica delle blindate Dierre.

Wall Security è disponibile anche nella versione doppio battente

Discrete, minimalist, open to endless personalization, Wall Security AT means clever design able to protect you from burglary attempts. Equipped with one of the most traditional and efficient closure systems, Wall Security AT protects your surroundings.

Dierre increases the level of security, thanks to the strength of a steel drill and burglar proof plate that protects the lock from tampering attempts and thanks to the interchangeable Mia block that allows, in case of theft, loss or suspect duplication of the keys, endless replacements of the key without changing the whole lock. With its unique double bit lock AT is the most classic of Dierre armoured doors.

at



DISPONIBILE ANCHE
IN VERSIONE
TAGLIAFUOCO EI₂30
Available also in the
fire-rated version EI₂30



SISTEMI DI APERTURA Opening systems

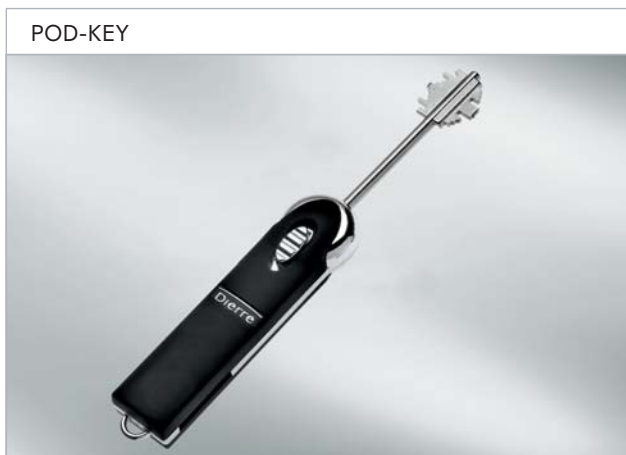

Chiave a scatto per serratura doppia mappa.
Flip-open key for double bit lock.

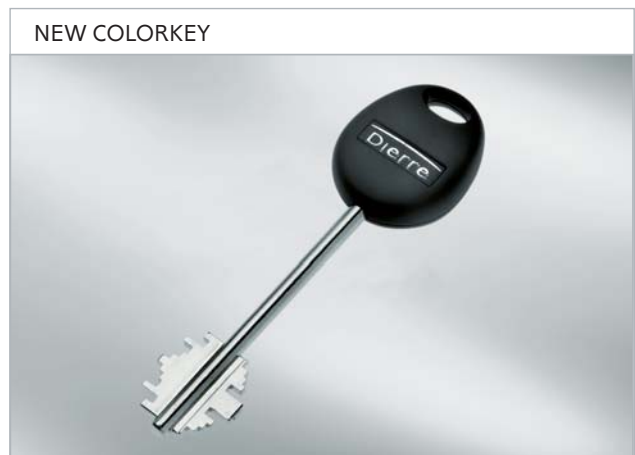

Chiave per serratura doppia mappa.
Key for double bit lock.



WALL SECURITY AT 3
CON RIVESTIMENTO
NEW MELAMINICO
45E PEWTER
(DISPONIBILE ANCHE CON
KIT TOP SECRET O SECRET)

Wall Security AT 3
with New Melaminico
45E Pewter panelling
(Available also with
Top Secret or Secret kits)

MOSTRINE Escutcheons

AT 3 - AT3 DB



Lato interno
Internal side

Lato esterno
External side

Lato interno
Internal side

Lato esterno
External side

AT3 DETTAGLIO SERRATURA AT3 Lock detail











FINITURE DI STILE Stylish finishes

<p>BIANCO White</p>	<p>NERO Black</p>	<p>BRONZO Bronze</p>
		
<p>ARGENTO (DI SERIE) Silver (Standard)</p>	<p>CROMO SATINATO Satin chrome</p>	<p>CROMO LUCIDO Polished chrome</p>
		
<p>OTTONE Brass</p>	<p>OTTONE RESISTA Resista brass</p>	
		



NUOVI COLORI PROFILI IN ALLUMINIO BATTENTE E TELAIO

New profile colours in aluminium for leaf and frame

<p>ROSSO Red</p>	<p>BLU Blue</p>	<p>GRIGIO CANNA DI FUCILE Dark Grey</p>
		
<p>ALLUMINIO ANODIZZATO ARGENTO (DI SERIE) Silver anodized aluminium (Standard)</p>	<p>NERO DIERRE Dierre Black</p>	<p>BIANCO DIERRE Dierre White</p>
		
<p>VERDE DIERRE Dierre Green</p>	<p>TESTA DI MORO Dark Brown</p>	<p>GRIGIO CHIARO Light Grey</p>
		

PARTICOLARI Details

CERNIERA A SCOMPARSA
Hide-away hinge



COPRIFILO IN ALLUMINIO SATINATO
Satin aluminium covermould



DETTAGLIO DOPPIO BATTENTE
Double leaf detail



ROSTRO A UNCINO ANTISCARDINAMENTO
Wrench-proof hook grip



SGANCIO ANTA SEMIFISSA
Semi-fixed leaf release



DETTAGLIO ANTA
Leaf detail



tec
ni
che

schede

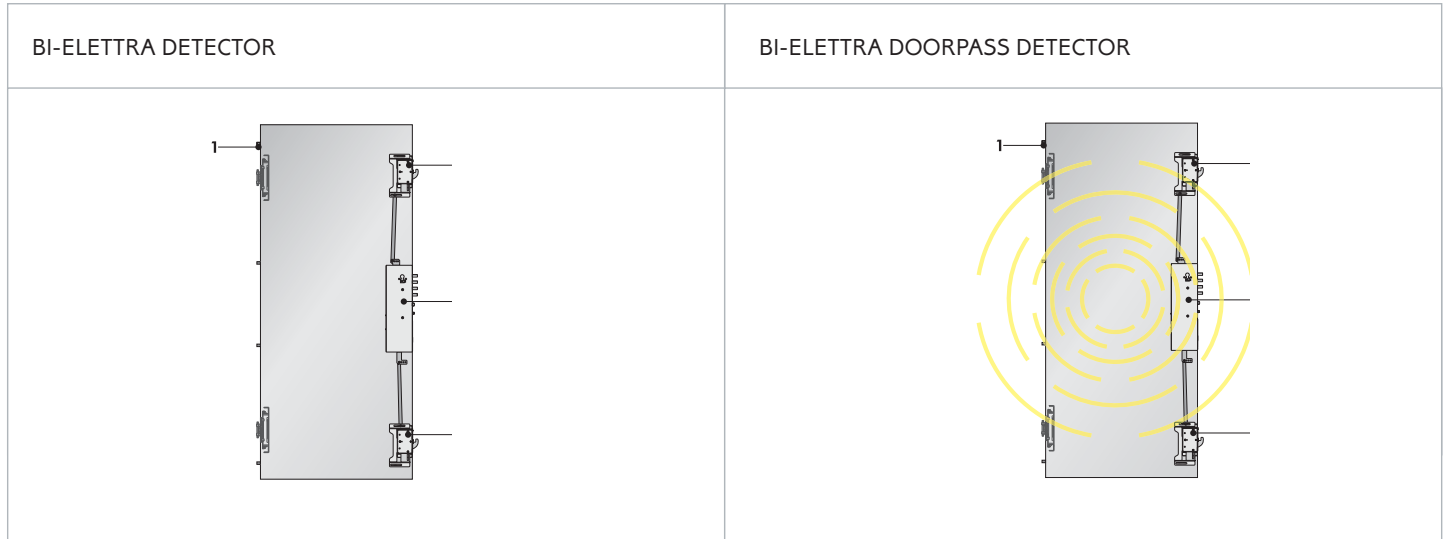

- 1 - 4 rostri fissi a gancio
 - 2 - Deviatore "Hook"
 - 3 - Serratura motorizzata triplice con sblocco manuale comandato da cilindro + scrocco
- 1 - 4 hook fixed grips
 - 2 - "Hook" deviator
 - 3 - Triple motorised lock with manual release controlled by the cylinder + latch

- 1 - 4 rostri fissi a gancio
 - 2 - Deviatore "Hook"
 - 3 - Serratura motorizzata triplice con sblocco manuale comandato da cilindro + scrocco
- 1 - 4 hook fixed grips
 - 2 - "Hook" deviator
 - 3 - Triple motorised lock with manual release controlled by the cylinder + latch

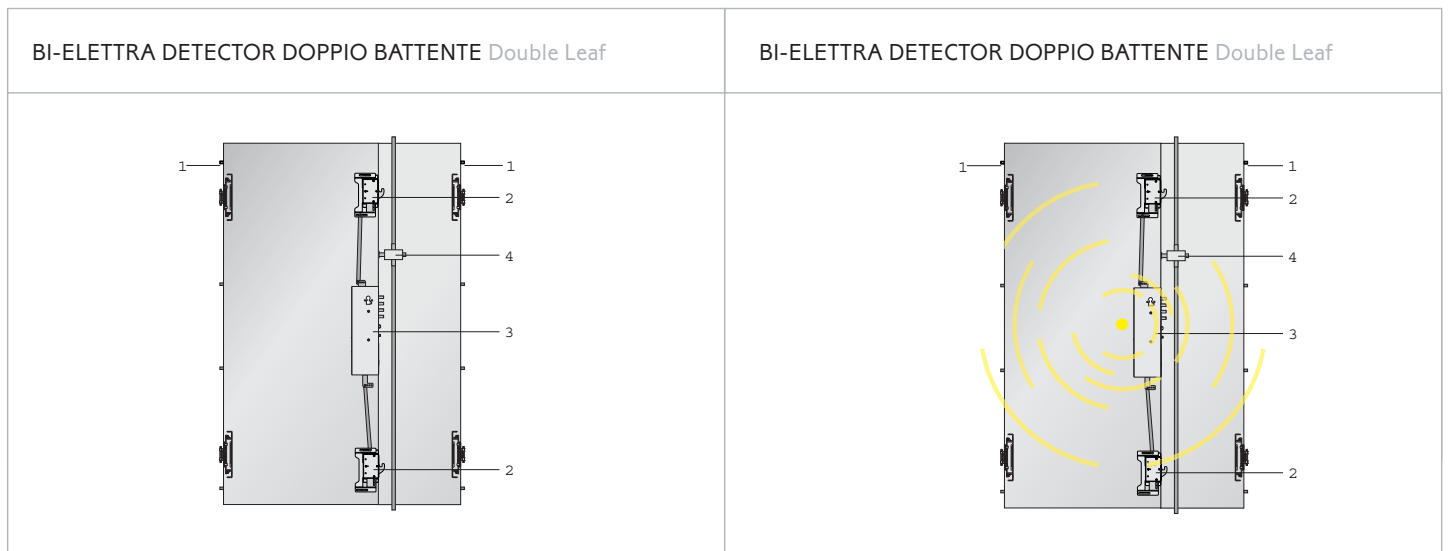

- 1 - n° 4 + 4 rostri fissi a gancio
 - 2 - Deviatore ad uncino "Hook"
 - 3 - Serratura motorizzata triplice con sblocco manuale comandato da cilindro + scrocco
 - 4 - Dispositivo di chiusura Anti Semifissa
- 1 - 4 + 4 hook fixed grips
 - 2 - "Hook" deviator
 - 3 - Triple motorised lock with manual release controlled by the cylinder + latch
 - 4 - Semi-fixed leaf closure device

- 1 - n° 4 + 4 rostri fissi a gancio
 - 2 - Deviatore ad uncino "Hook"
 - 3 - Serratura motorizzata triplice con sblocco manuale comandato da cilindro + scrocco
 - 4 - Dispositivo di chiusura Anti Semifissa
- 1 - 4 + 4 hook fixed grips
 - 2 - "Hook" deviator
 - 3 - Triple motorised lock with manual release controlled by the cylinder + latch
 - 4 - Semi-fixed leaf closure device

RAPPRESENTAZIONE GRAFICA DEL BATTENTE

Drawing of the leaf

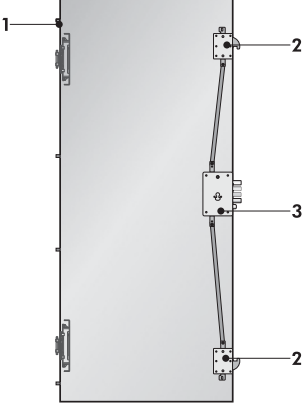
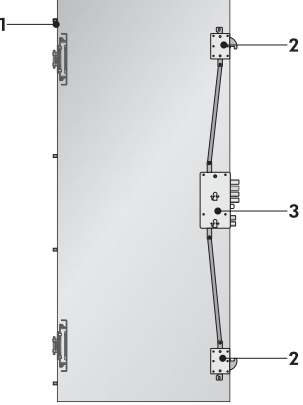
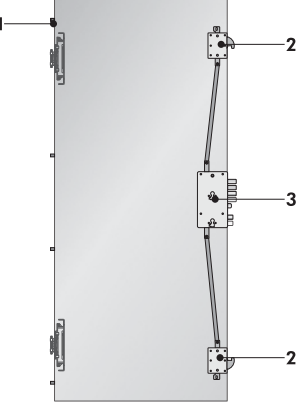
SENTRY 1	SENTRY 4	SENTRY DOUBLE
		

- 1 - 4 rostri fissi a gancio
- 2 - Deviatore ad uncino "Hook"
- 3 - Serratura triplice: a cilindro
- 1 - 4 hook fixed grips
- 2 - "Hook" deviator
- 3 - Triple cylinder lock

- 1 - 4 rostri fissi a gancio
- 2 - Deviatore ad uncino "Hook"
- 3 - Serratura triplice: a cilindro superiore alta sicurezza; cilindro inferiore di servizio
- 1 - 4 hook fixed grips
- 2 - "Hook" deviator
- 3 - Triple lock with: high security upper cylinder; lower service cylinder

- 1 - 4 rostri fissi a gancio
- 2 - Deviatore ad uncino "Hook"
- 3 - Serratura triplice: doppio cilindro ad alta sicurezza
- 1 - 4 hook fixed grips
- 2 - "Hook" deviator
- 3 - Triple lock: double high security cylinder

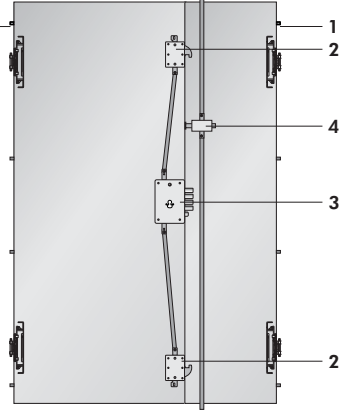
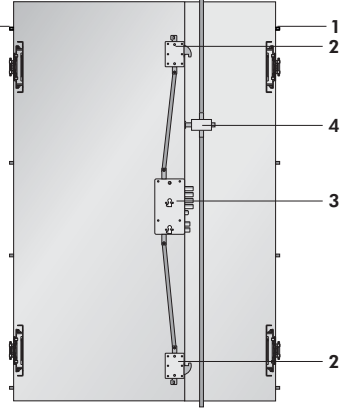
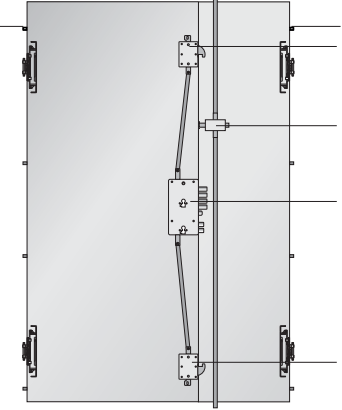
SENTRY 1 DOPPIO BATTENTE Double Leaf	SENTRY 4 DOPPIO BATTENTE Double Leaf	SENTRY DOUBLE DOPPIO BATTENTE Double Leaf
		

- 1 - n° 4 + 4 rostri fissi a gancio
- 2 - Deviatore ad uncino "Hook"
- 3 - Serratura triplice
- 4 - Dispositivo di chiusura Anta Semifissa
- 1 - 4 + 4 hook fixed grips
- 2 - "Hook" deviator
- 3 - Triple lock
- 4 - Semi-fixed leaf closure device

- 1 - n° 4 + 4 rostri fissi a gancio
- 2 - Deviatore ad uncino "Hook"
- 3 - Serratura triplice: a cilindro superiore ad alta sicurezza; cilindro inferiore di servizio
- 4 - Dispositivo di chiusura Anta Semifissa
- 1 - 4 + 4 hook fixed grips
- 2 - "Hook" deviator
- 3 - Triple lock with: high security upper cylinder; lower service cylinder
- 4 - Semi-fixed leaf closure device

- 1 - n° 4 + 4 rostri fissi a gancio
- 2 - Deviatore ad uncino "Hook"
- 3 - Serratura triplice: doppio cilindro ad alta sicurezza
- 4 - Dispositivo di chiusura Anta Semifissa
- 1 - 4 + 4 hook fixed grips
- 2 - "Hook" deviator
- 3 - Triple lock with: double high security cylinder;
- 4 - Semi-fixed leaf closure device

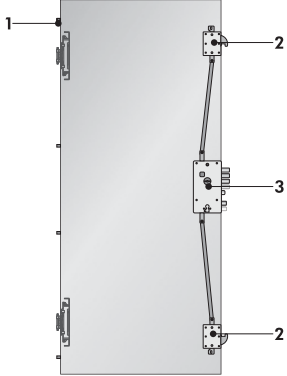
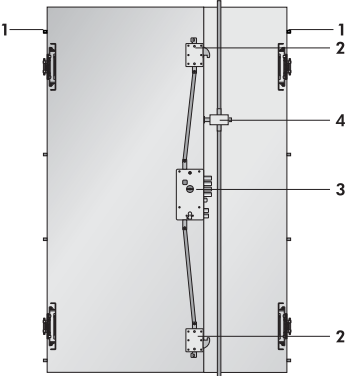
<p>HI-FI</p>	<p>HI-FI DOPPIO BATTENTE Double leaf</p>
	

- 1 - 4 rostri fissi a gancio
- 2 - Deviatore ad uncino "Hook"
- 3 - Serratura triplice doppia mappa + cilindro inferiore ad alta sicurezza

- 1 - 4 hook fixed grips
- 2 - "Hook" deviator
- 3 - Double bit Triple lock + high security lower cylinder

- 1 - n° 4 + 4 rostri fissi a gancio
- 2 - Deviatore ad uncino "Hook"
- 3 - Serratura triplice doppia mappa + cilindro inferiore ad alta sicurezza
- 4 - Dispositivo di chiusura Anti Semifissa

- 1 - 4 + 4 hook fixed grips
- 2 - "Hook" deviator
- 3 - Double bit Triple lock + high security lower cylinder
- 4 - Semi-fixed leaf closure device

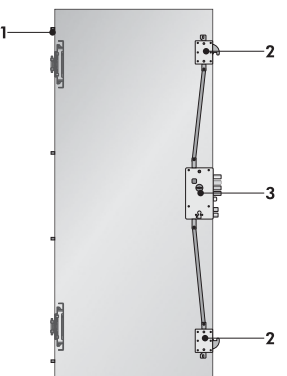
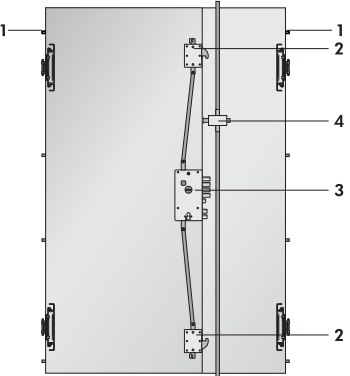
<p>AT 3</p>	<p>AT 3 DOPPIO BATTENTE Double leaf</p>
	

- 1 - 4 rostri fissi a gancio
- 2 - Deviatore ad uncino "Hook"
- 3 - Serratura triplice doppia mappa + cilindro inferiore di servizio

- 1 - 4 hook fixed grips
- 2 - "Hook" deviator
- 3 - Double bit Triple lock + Lower service cylinder

- 1 - n° 4 + 4 rostri fissi a gancio
- 2 - Deviatore ad uncino "Hook"
- 3 - Serratura triplice doppia mappa + cilindro inferiore di servizio
- 4 - Dispositivo di chiusura Anti Semifissa

- 1 - 4 + 4 hook fixed grips
- 2 - "Hook" deviator
- 3 - Double bit Triple lock + Lower service cylinder
- 4 - Semi-fixed leaf closure device

KIT SECRET E TOP SECRET Secret and Top Secret Kit

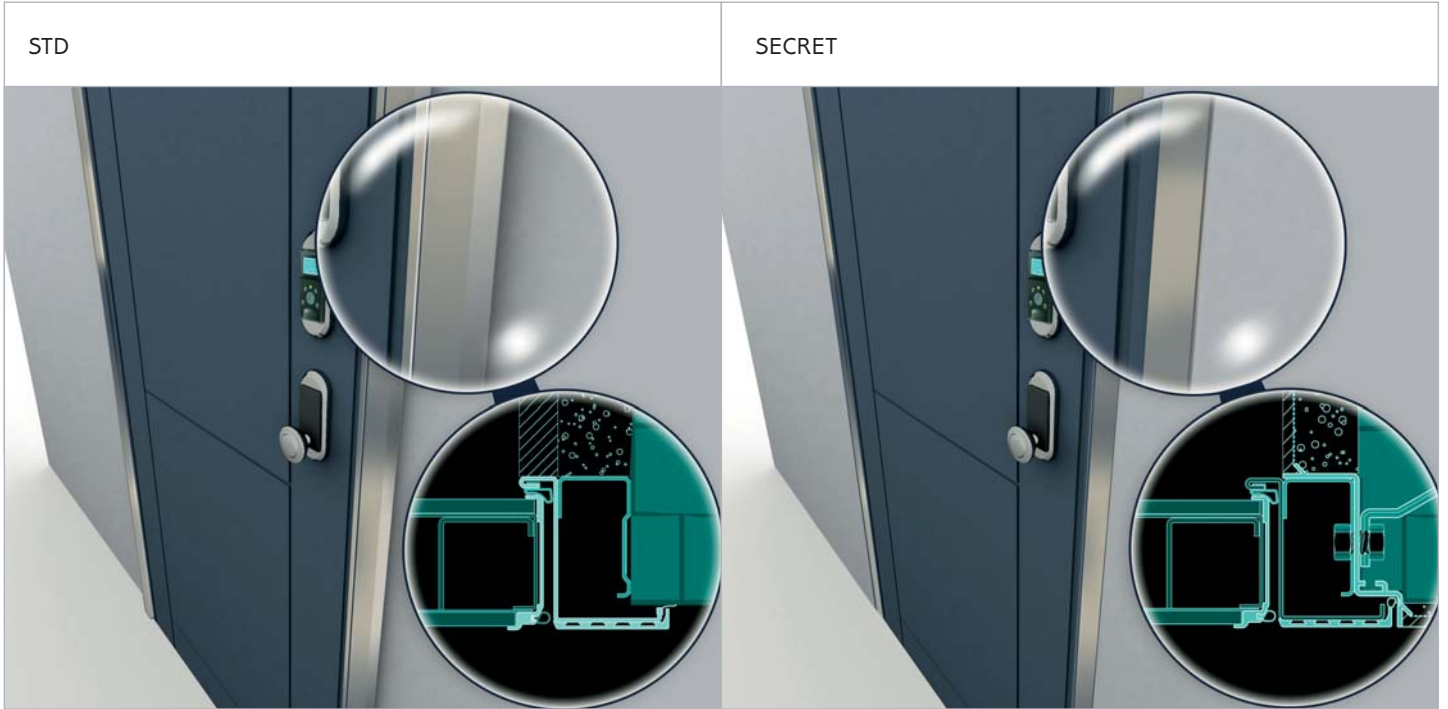

SCHEMA TECNICO PROFILO SECRET UN BATTENTE

Single leaf Secret profile technical diagram

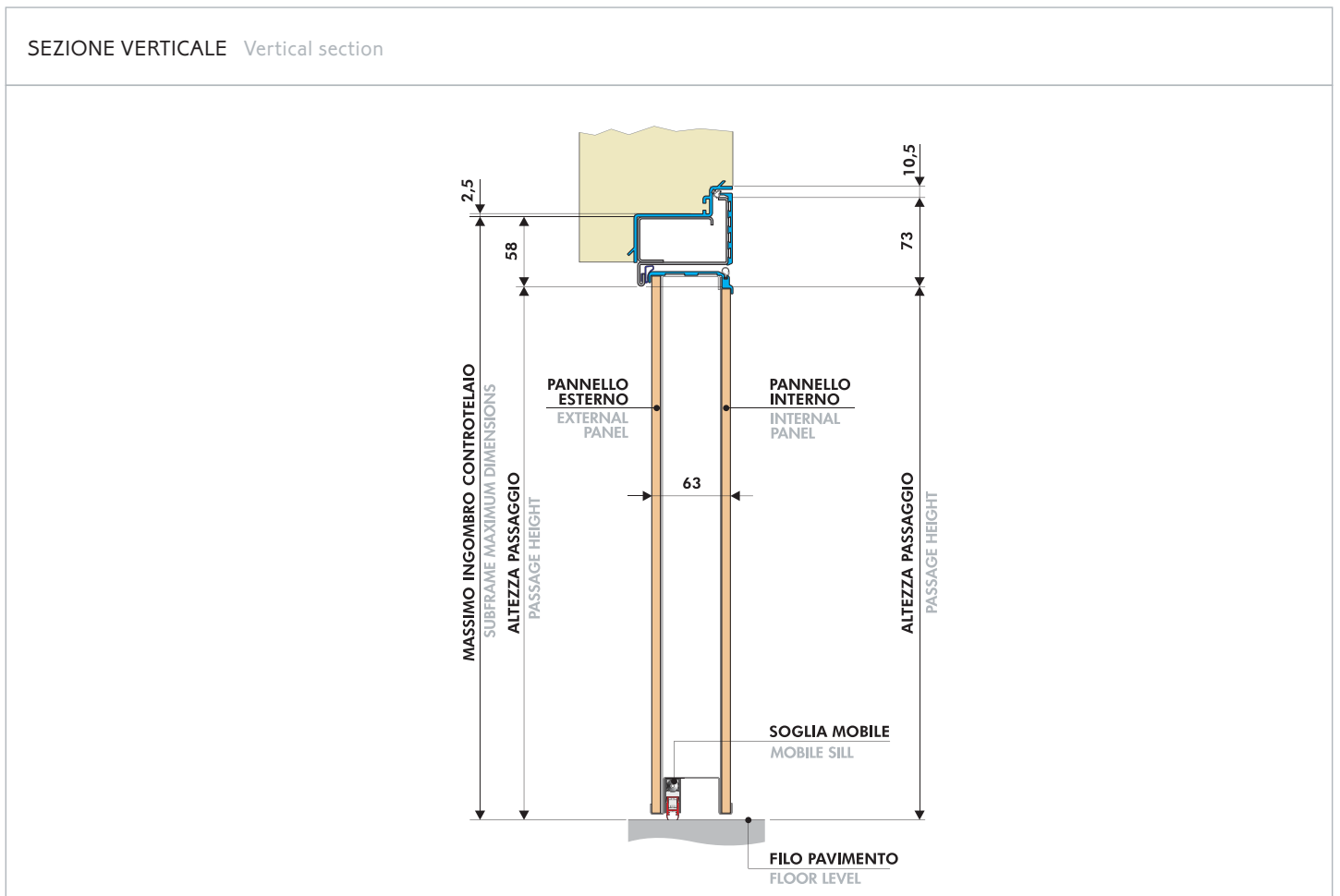
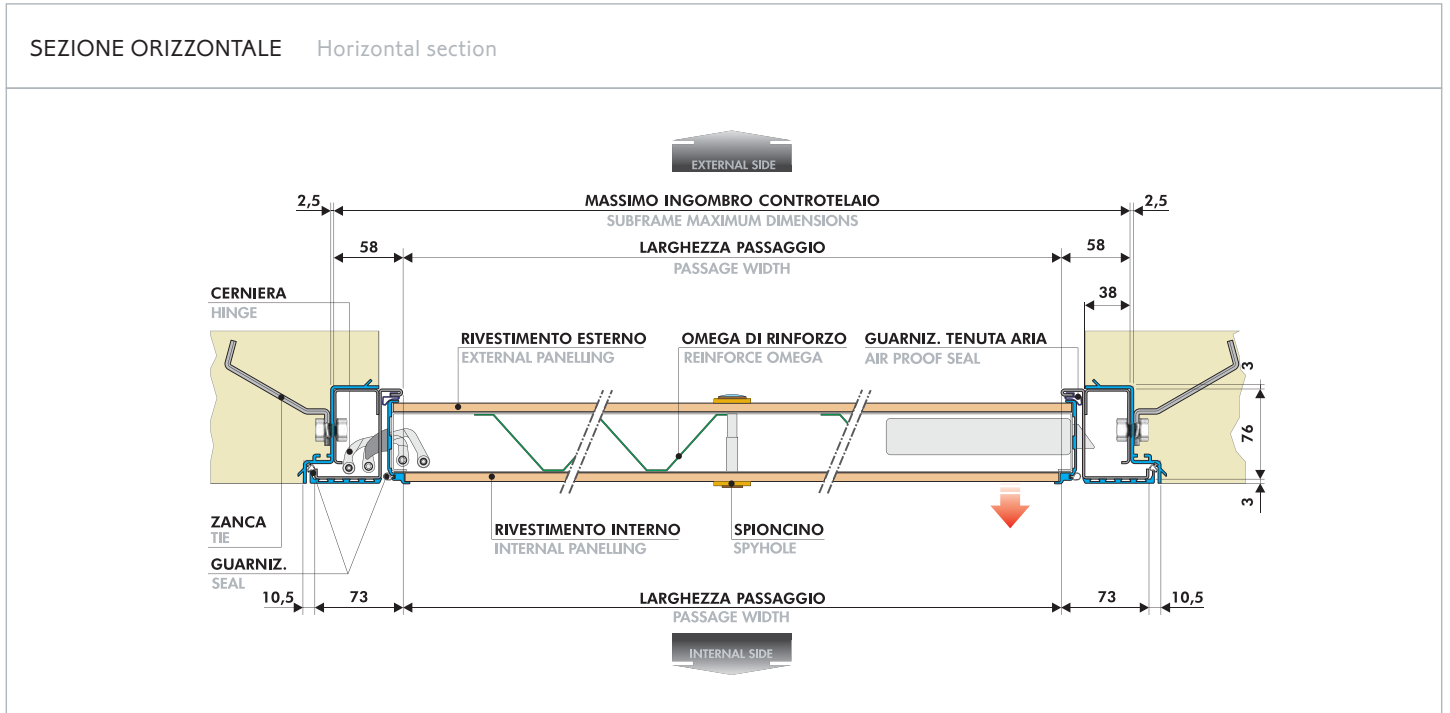

SCHEMA TECNICO PROFILO SECRET DOPPIO BATTENTE

Double leaf Secret profile technical diagram

SEZIONE ORIZZONTALE Horizontal section

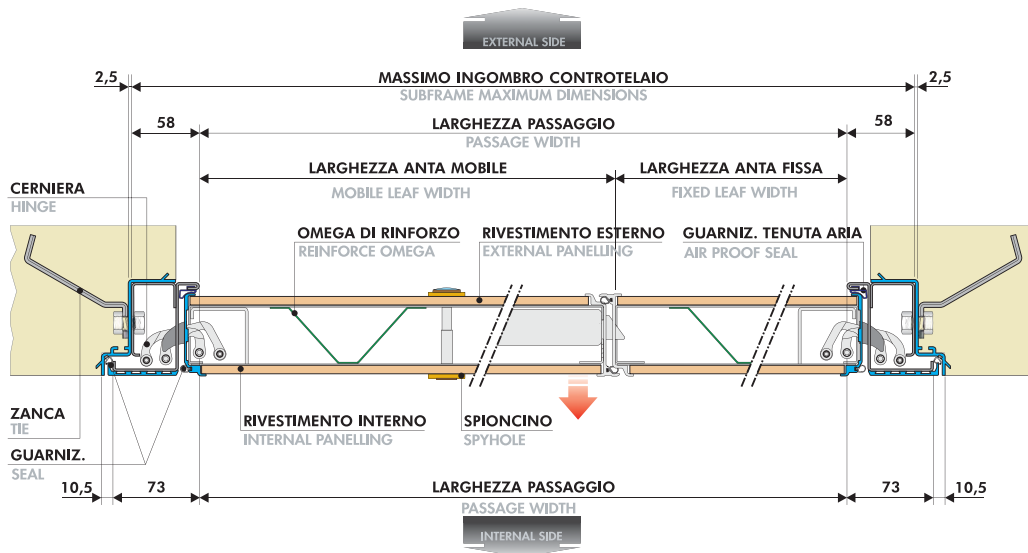

SEZIONE VERTICALE Vertical section

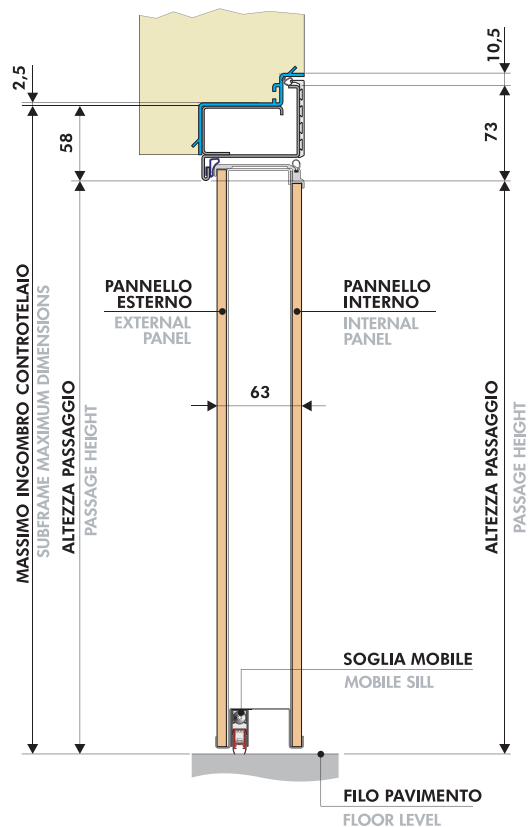

SCHEMA TECNICO PROFILO TOP SECRET UN BATTENTE

Single leaf Top Secret profile technical diagram

SEZIONE ORIZZONTALE Horizontal section

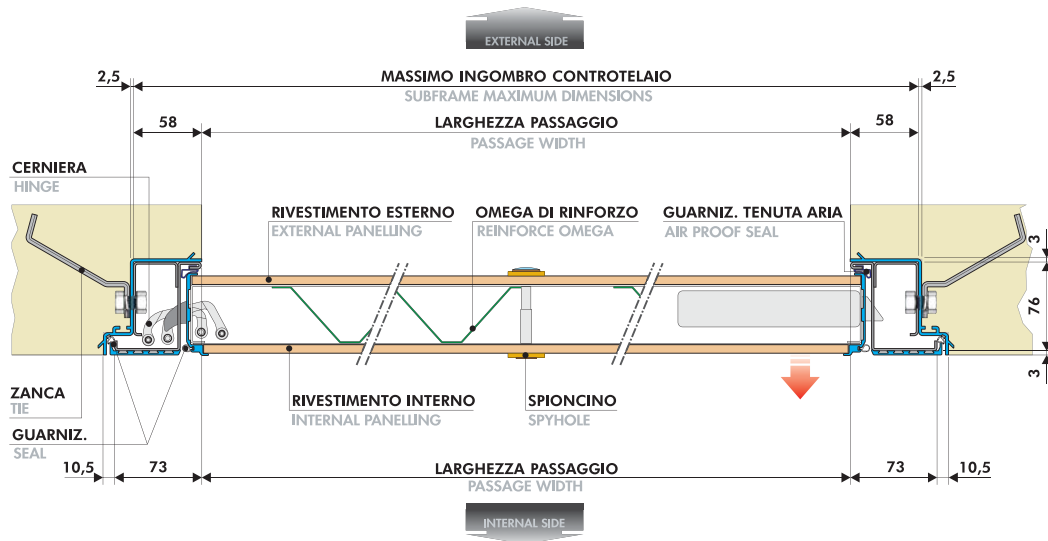

SEZIONE VERTICALE Vertical section

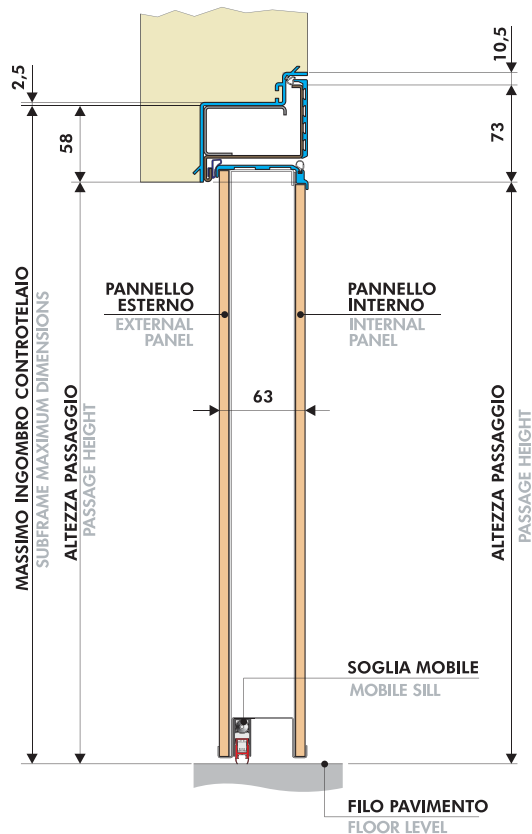

SCHEMA TECNICO PROFILO TOP SECRET DOPPIO BATTENTE

Double leaf Top Secret profile technical diagram

SEZIONE ORIZZONTALE Horizontal section

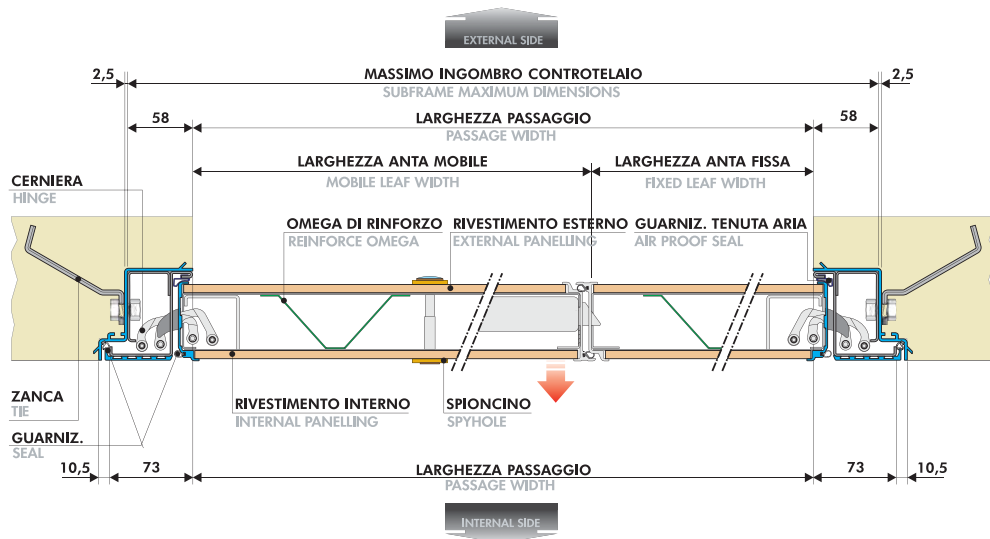

SEZIONE VERTICALE Vertical section

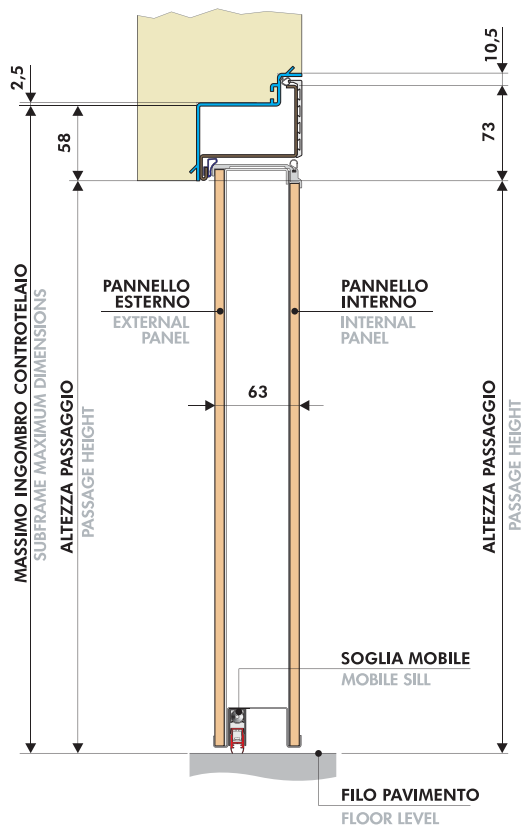

WALL SECURITY CON FINESTRATURA RETTANGOLARE Wall Security with rectangular glazing

SEZIONE VERTICALE Vertical section

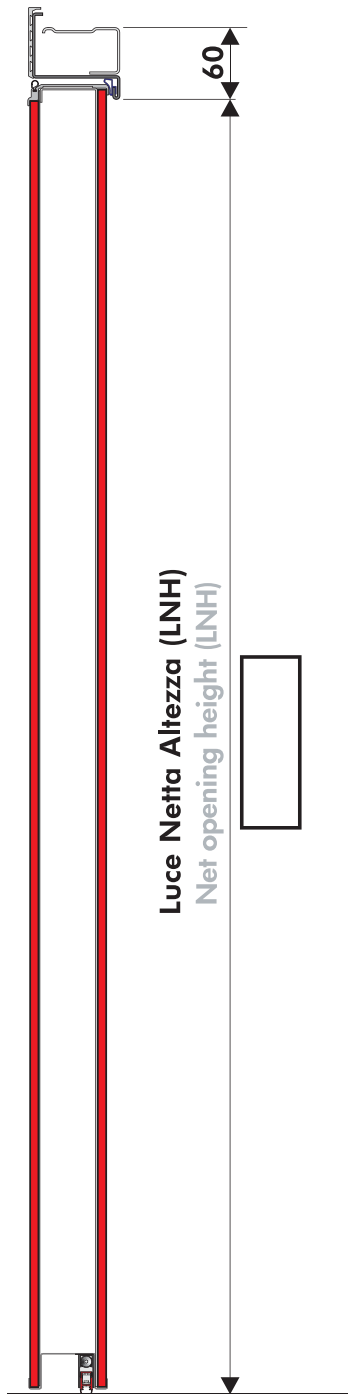

VISTA LATO INTERNO Internal side view

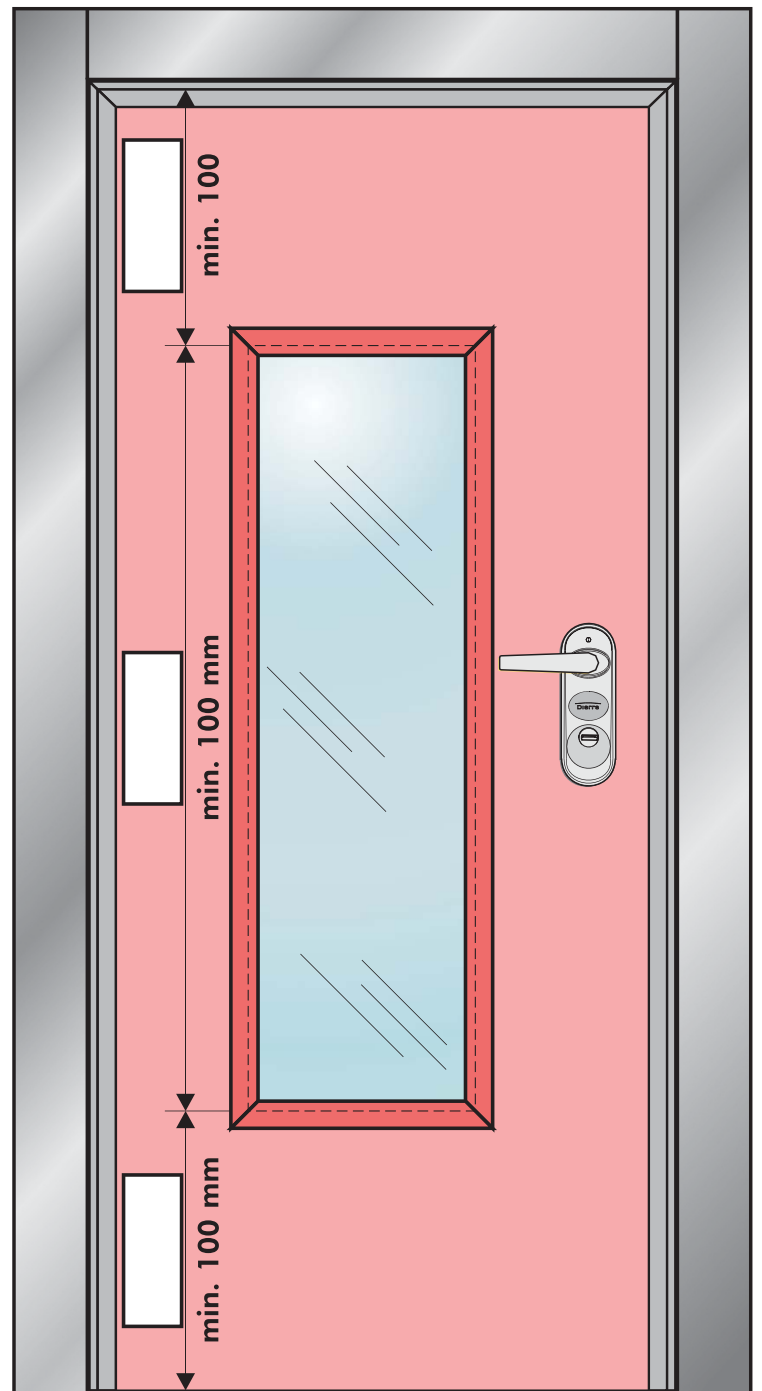

SEZIONE ORIZZONTALE Horizontal section

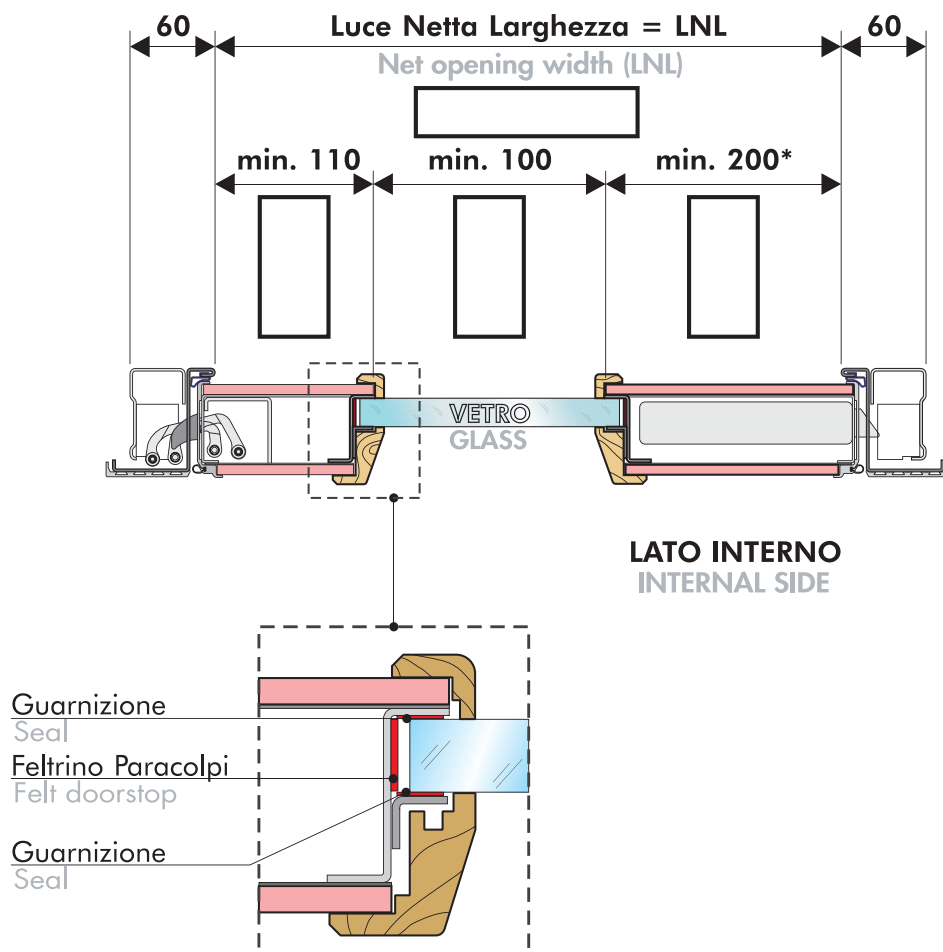

É obbligatorio attenersi alle seguenti regole:

- Prevedere un gioco d'uso di c.a di 10mm tra Vano muro e Controtelaio.
- Largh. min. finestrature = 100mm.
- Largh. min. montante lato serratura = 200mm (*260 per Wall Security Bi-Elettra).
- Largh. min. montante lato cerniere = 110mm.

The following rules must be complied with:

- Leave a 10mm approximately usage play between wall opening and subframe.
- Min. glazing width = 100mm.
- Min. lock side jamb width = 200mm (*260 for Wall Security Bi-Elettra).
- Min. hinge side jamb width = 110mm.

WALL SECURITY CON SOPRALUCE PREDISPOSTO VETRO

Wall Security with overhead doorlight prepared for glass

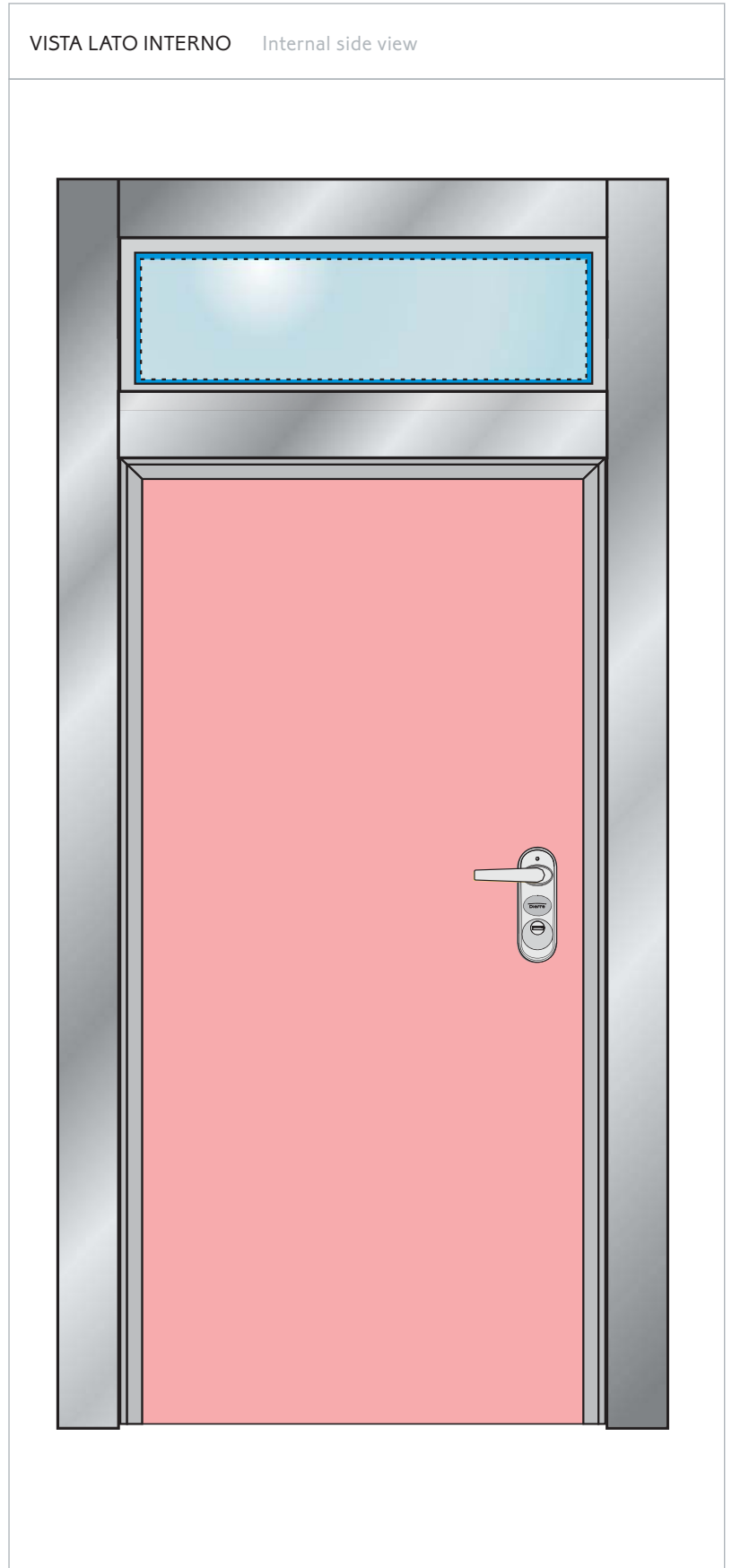
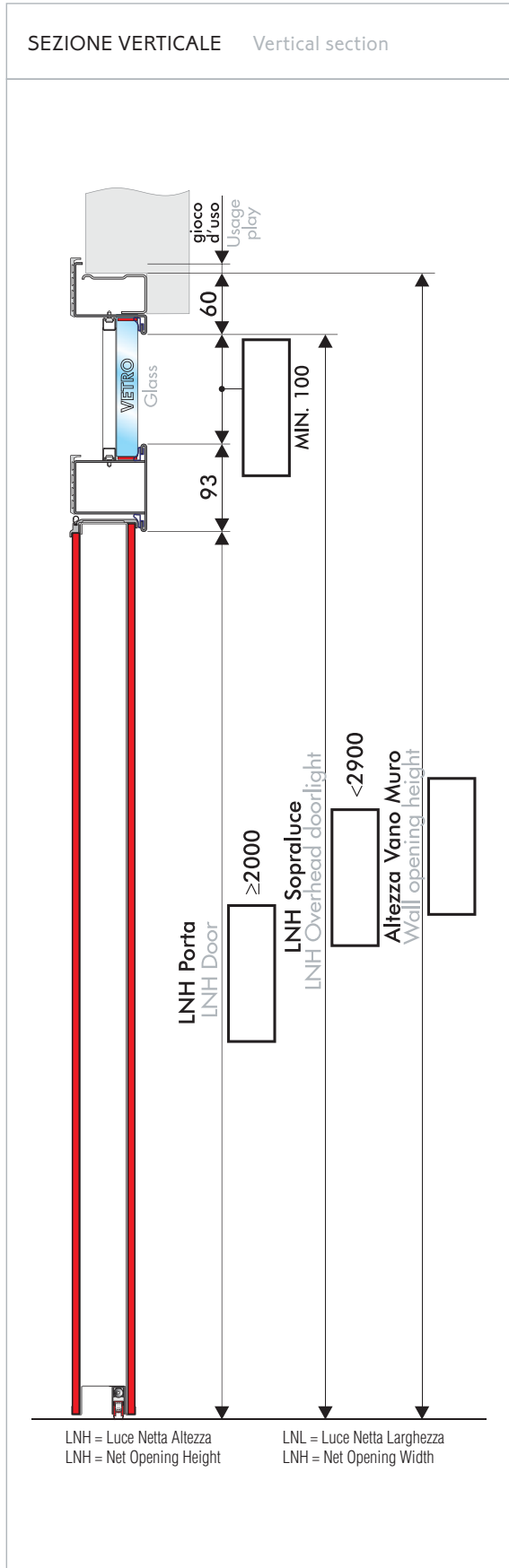

SEZIONE ORIZZONTALE Horizontal section

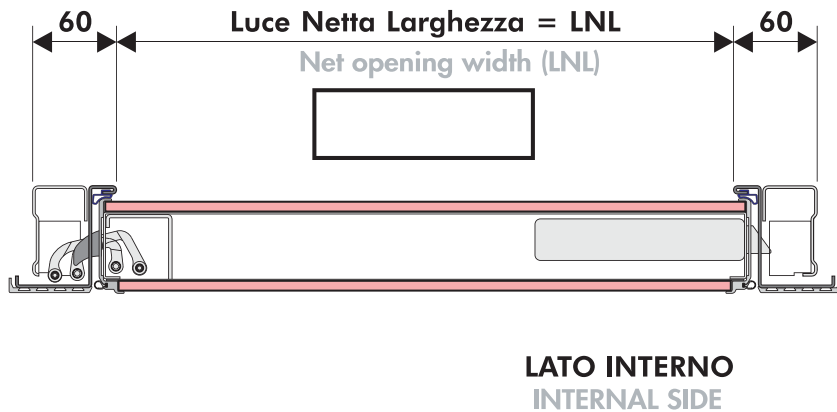

É obbligatorio attenersi alle seguenti regole:

- Prevedere un gioco d'uso di c.a di 10mm tra Vano muro e Controtelaio.
- LNH porta min. 2000mm
- LNH sopra luce max 2900mm
- Altezza min. sopra luce = 100mm.

The following rules must be complied with:

- Leave a 10mm approximately usage play between wall opening and subframe.
- Door Net Opening Height 2000mm.
- Overhead doorlight Net Opening Height max 2900mm.
- Overhead minimum Height = 100mm.

WALL SECURITY DOPPIO BATTENTE CON SOPRALUCE PREDISPOSTO VETRO

Wall Security double leaf with overhead doorlight prepared for glass

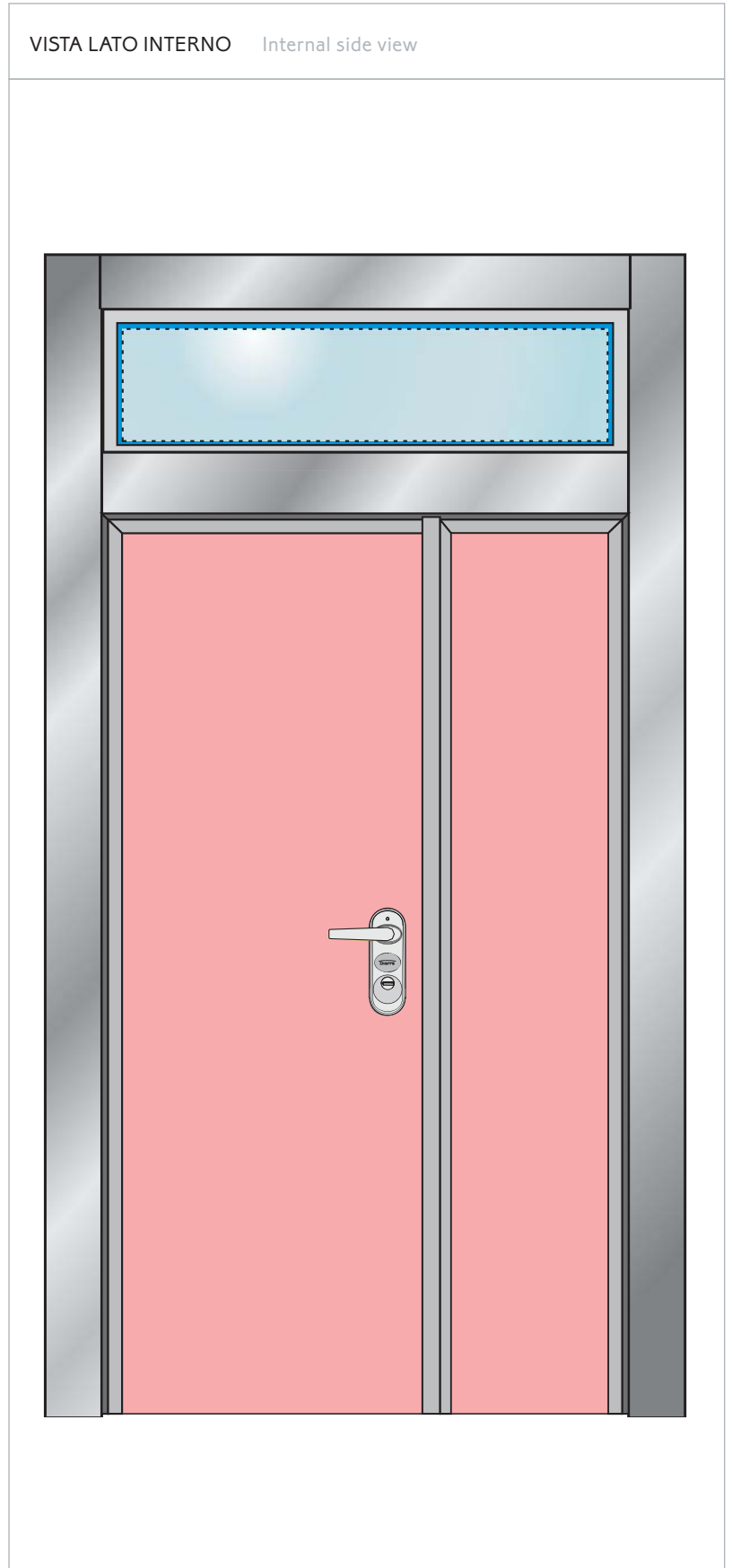
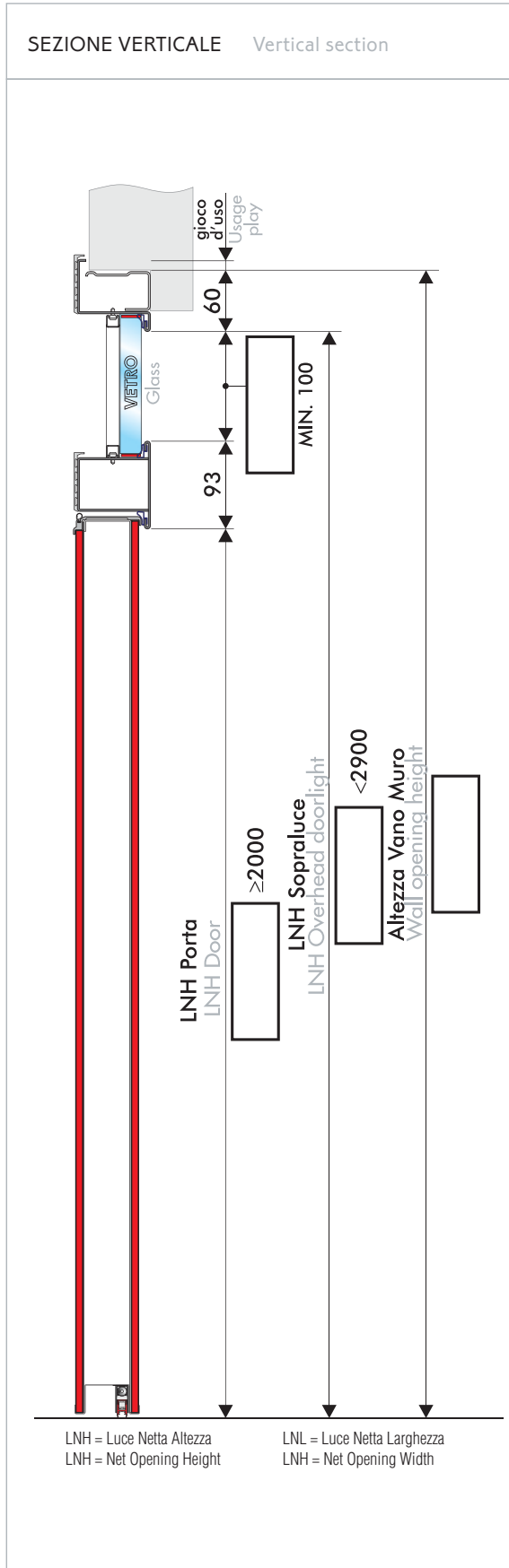

SEZIONE ORIZZONTALE Horizontal section

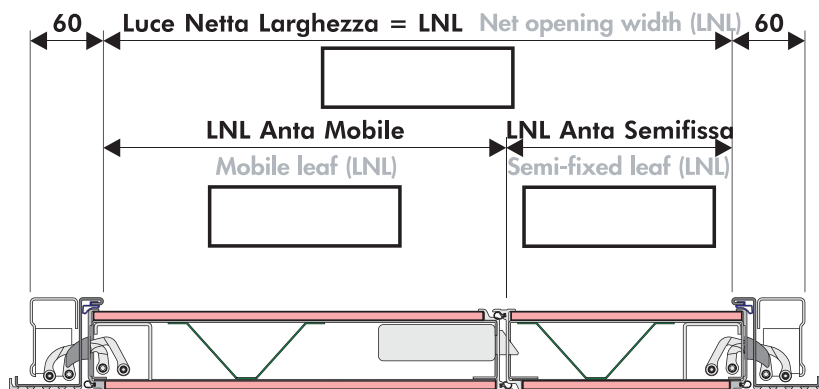

É obbligatorio attenersi alle seguenti regole:

- Prevedere un gioco d'uso di c.a di 10mm tra Vano muro e Controtelaio.
- LNH porta min. 2000mm
- LNH sopra luce max 2900mm
- Altezza min. sopra luce = 100mm.

The following rules must be complied with:

- Leave a 10mm approximately usage play between wall opening and subframe.
- Door Net Opening Height 2000mm.
- Overhead doorlight Net Opening Height max 2900mm.
- Overhead minimum Height = 100mm.

SCHEMA TECNICO UN BATTENTE

Single leaf technical diagram

SEZIONE ORIZZONTALE Horizontal section

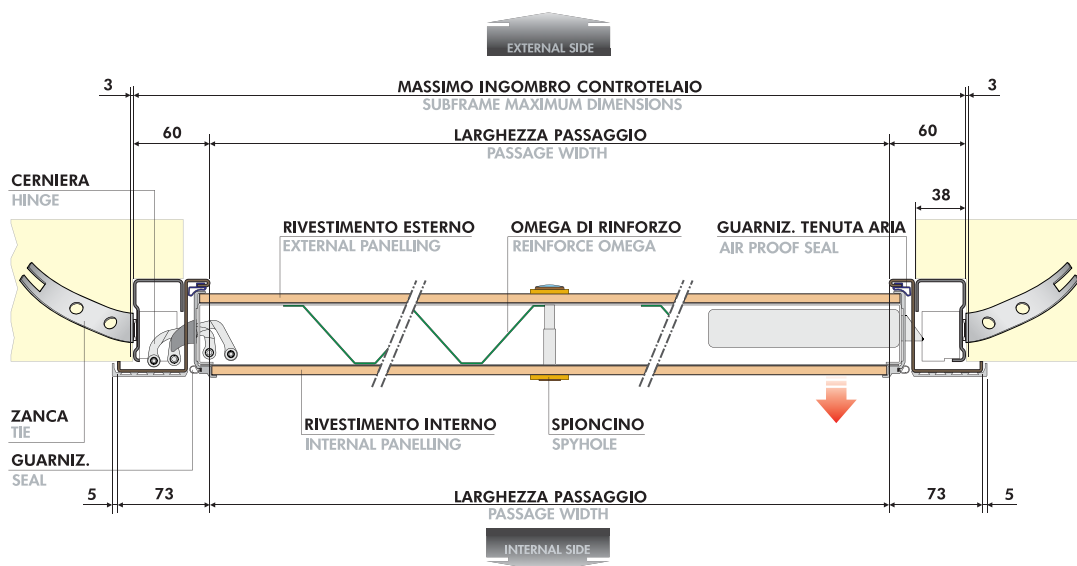

SEZIONE VERTICALE Vertical section

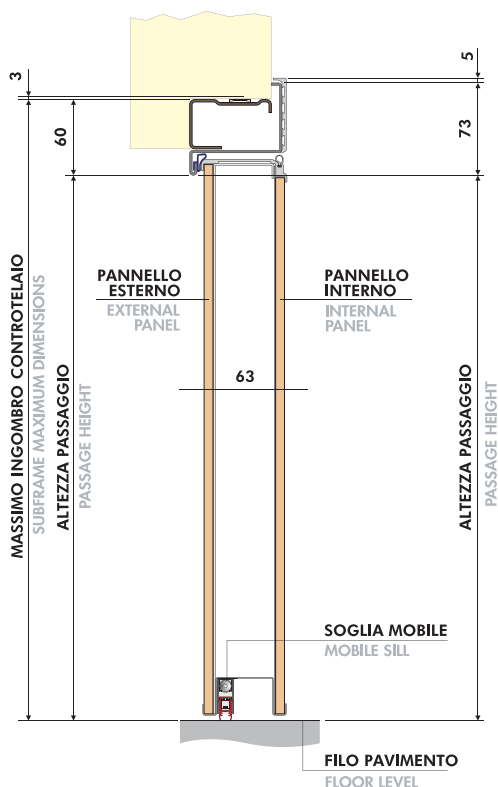

SCHEMA TECNICO DOPPIO BATTENTE

Double leaf technical diagram

SEZIONE ORIZZONTALE Horizontal section

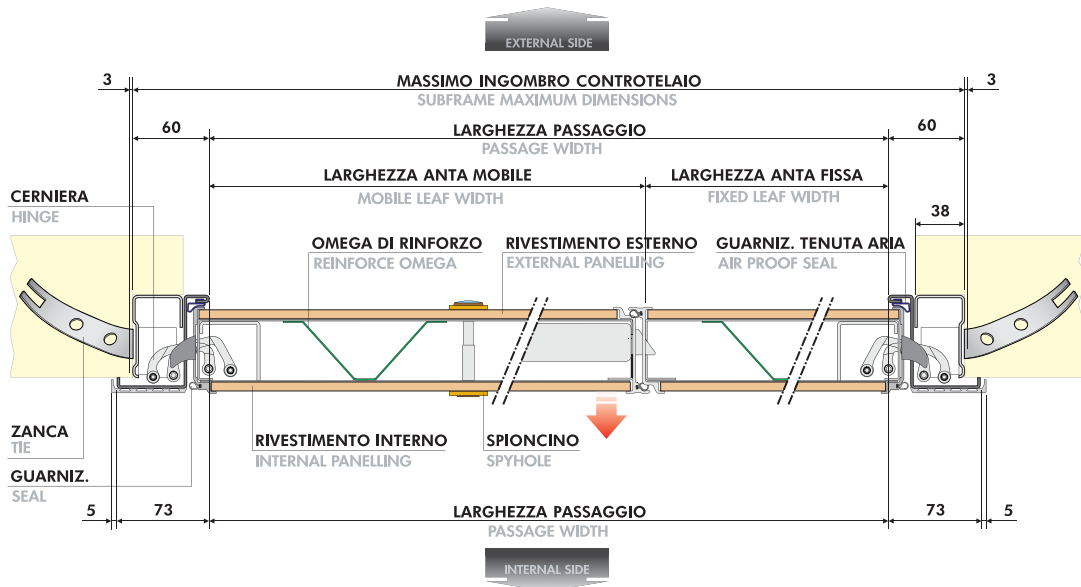

SEZIONE VERTICALE Vertical section

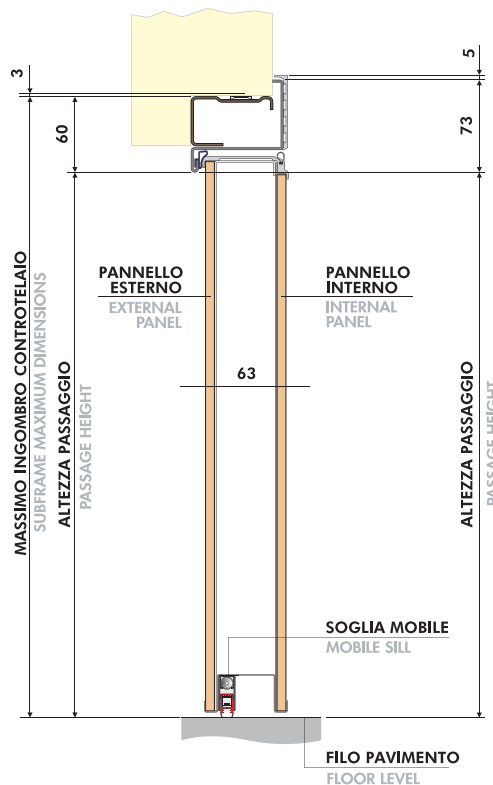

MISURE TELAIO E CONTROTELAIO Frame and sub-frame dimensions

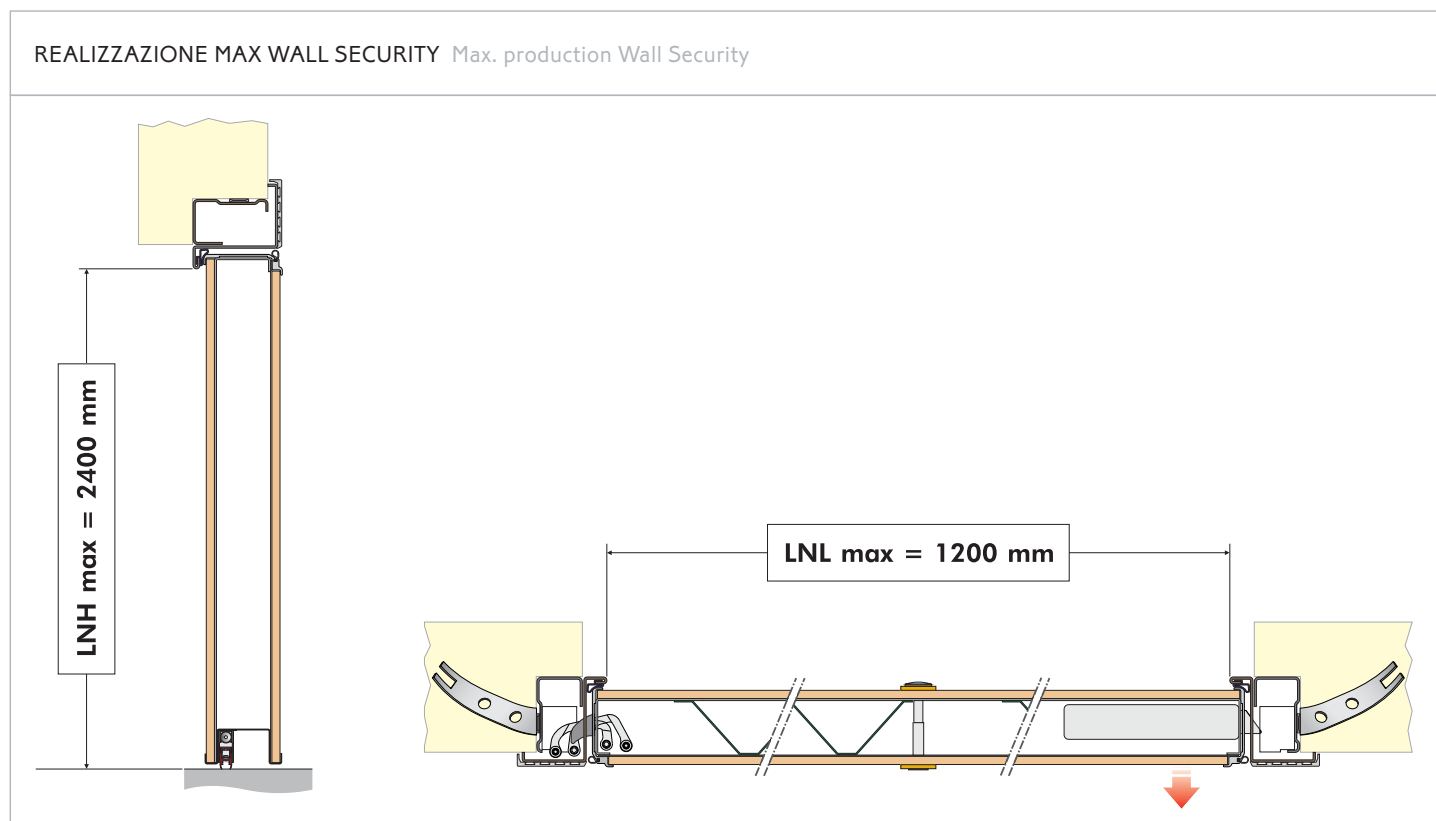
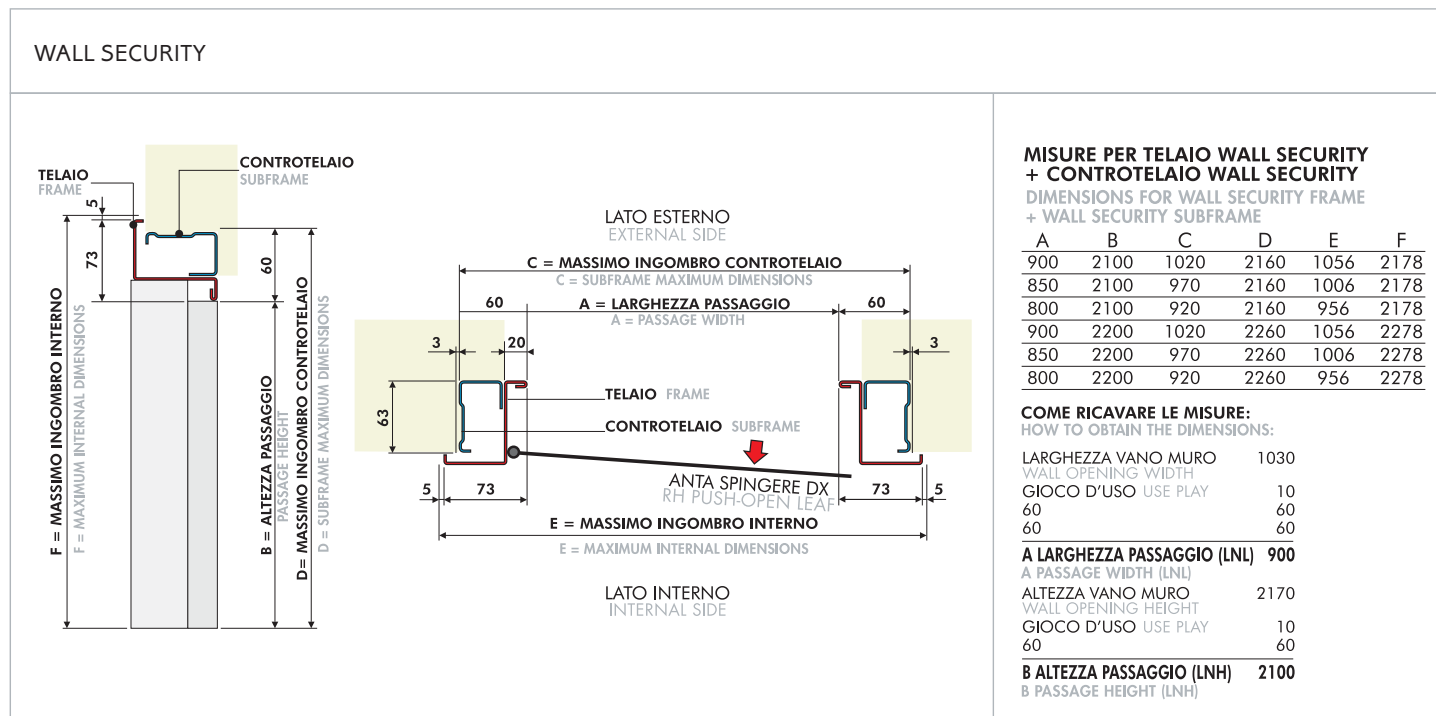

Grazie alla sua struttura ed alle imponenti cerniere, la Wall Security è adatta alla realizzazione di chiusure di grandi dimensioni. Si possono realizzare porte aventi LNH max 2400 mm e LNL max 2400 mm con sole 2 cerniere.

Thanks to its structure and to the substantial hinges, Wall Security is suitable to be fitted where large spaces have to be closed-in. Doors having 2400 mm as maximum height and 2400 mm as maximum width can be produced with 2 hinges only.

REALIZZAZIONE MAX WALL SECURITY DOPPIO BATTENTE Max. production Wall Security Double Leaf

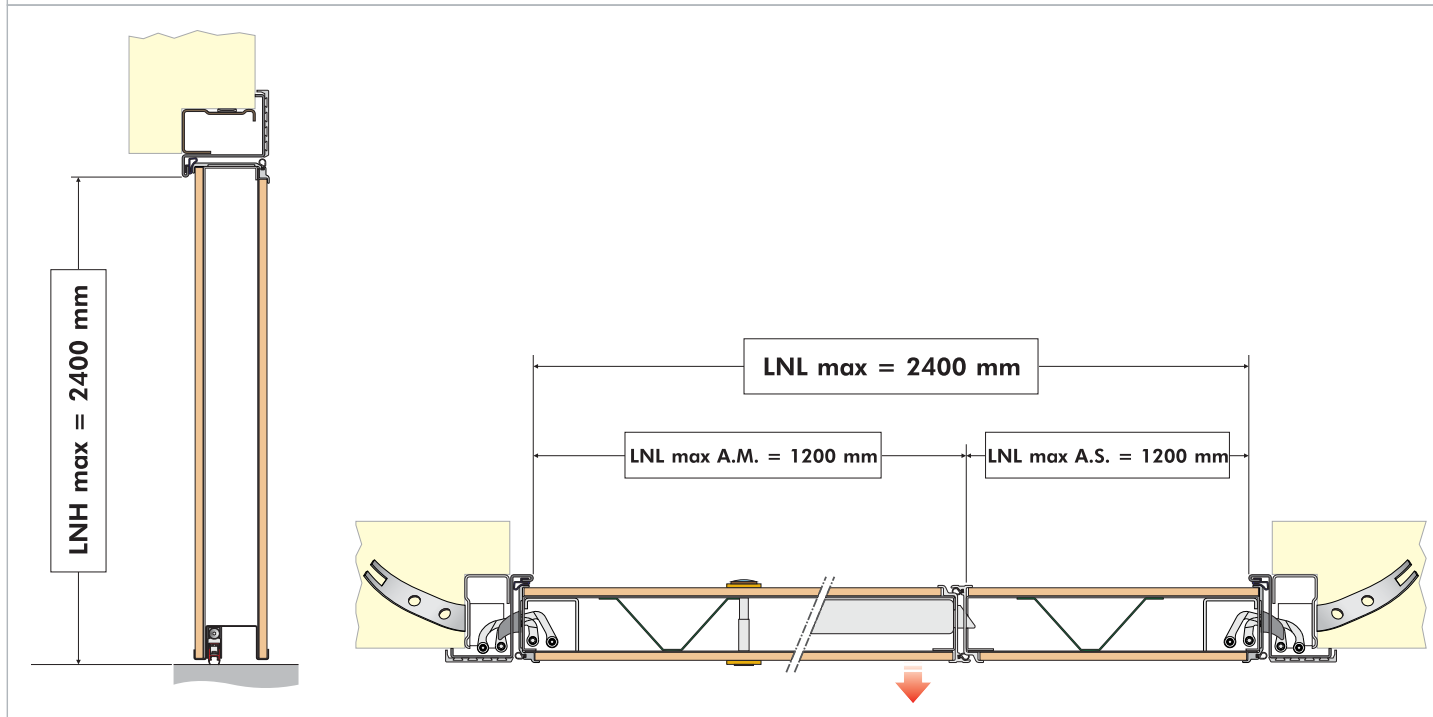

Grazie alla sua struttura ed alle imponenti cerniere, la Wall Security è adatta alla realizzazione di chiusure di grandi dimensioni. Si possono realizzare porte aventi LNH max 2400 mm e LNL max 2400 mm con sole 4 cerniere.

Thanks to its structure and to the substantial hinges, Wall Security is suitable to be fitted where large spaces have to be closed-in. Doors having 2400 mm as maximum height and 2400 mm as maximum width can be produced with 4 hinges only.

ESEMPI DI INSTALLAZIONE Installation examples

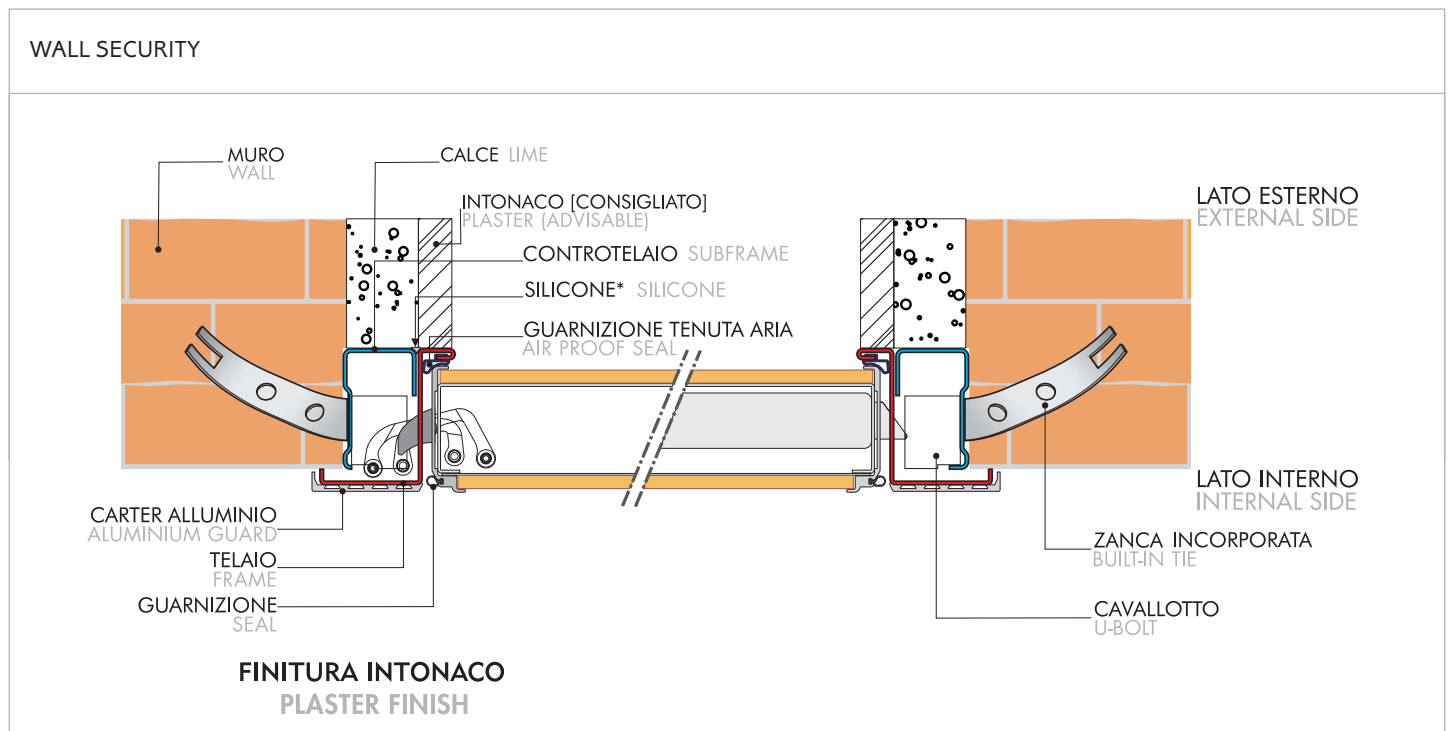
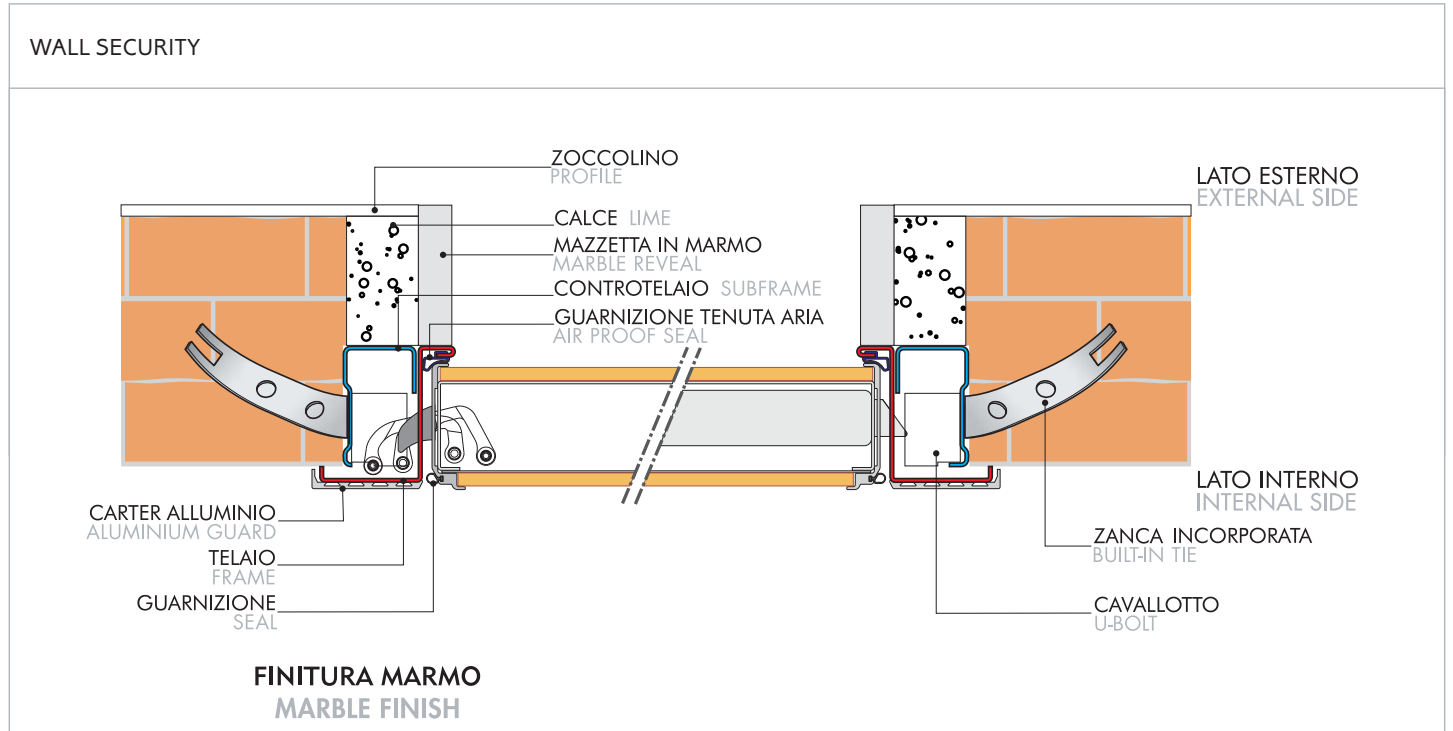

WALL SECURITY: CARATTERISTICHE PRESTAZIONALI UN BATTENTE

Wall Security: performance features - single leaf



ABBATTIMENTO TERMICO DA 2.2 A 1.1 W/M2.K SECONDO EN ISO 100771
THERMAL INSULATION FROM 2.2 TO 1.1 W/M2.K FOLLOWING EN ISO 100771



ABBATTIMENTO ACUSTICO DA 38 dB A 42 dB SECONDO EN ISO 140/3 E EN ISO 717-1
SOUND INSULATION FROM 38 dB TO 42 dB FOLLOWING EN ISO 140/3 AND EN ISO 717-1



RESISTENZA ALL'EFFRAZIONE CLASSE 3 SECONDO ENV 1627
BREAK-IN RESISTANCE CLASS 3 FOLLOWING ENV 1627



TENUTA AL VENTO FINO A CLASSE C5 SECONDO UNI EN 12210
RESISTANCE TO WIND LOAD UP TO CLASS C5 FOLLOWING UNI EN 12210



PERMEABILITÀ ALL'ARIA FINO A CLASSE 4 SECONDO UNI EN 12207
AIR PERMEABILITY UP TO CLASS 4 FOLLOWING UNI EN 12207



PROTEZIONE TAGLIAFUOCO EI₂ 30
FIREPROOF EI₂ 30 PROTECTION

Caratteristiche prestazionali Performance features	Ws Bi-Elettra	Ws Sentry	Ws Hi-Fi	Ws At
Abbattimento acustico (di serie) 38 Db Sound proofing (standard) 38 Db	●	●	●	●
Antieffrazione classe 3 (di serie) Burglar proof in class 3 (standard)	●	●	●	●
Trasmittanza Termica 1 battente (1,9) Thermal transmittance single leaf (1,9)	●	●	●	●
Struttura alto isolamento termico High thermal insulation structure	●*	●	●	●
Altri valori (consultare tabella Dierre Green) Other values (consult Dierre Green table)				
Tagliafuoco versione EI ₂ 30 Fire rated version EI ₂ 30		●	●	●
Tagliafuoco versione EI ₂ 30 a tirare 1 battente Fire rated pull version EI ₂ 30 single leaf		●	●	●
Versione a tirare 1 battente Pull version single leaf	●	●	●	●
Versione doppio battente Double leaf version	●	●	●	●
Equipaggiamento di serie Standard equipment				
Scocca monoblocco coibentata Insulated single-block body	●	●	●	●
Cassetta postale (min. LNLPOR = 650 mm) Letter box (min door width = 650 mm)	●	●	●	●
Display in multilingua Multilanguage display	●			
Cilindro alta sicurezza R11 "New Power" High security cylinder R11 "New Power"	●	●	●	
Spioncino grandangolare 200° Wide angle spy hole 200°	●	●	●	●
Lamina parafreddo Cold blocking sill	●	●	●	●
Doppio deviatore hook Double hook deviator	●	●	●	●
Rostrì fissi ad uncino Hook-type fixed grips	●	●	●	●
Cerniere a scomparsa registrabili sui 3 assi Hide-away hinges adjustable on 3 axles	●	●	●	●
Trasformatore marchiato CE CE marked transformer	●			
Chiave Jackey Jack key	●	●	●	
Chiave Pod key Pod key			●	●
Chiave New colorkey New colorkey key			●	●
Chiave Key card Key card key	●			
Chiave key control Key control key	●			
Lastra al manganese a protezione serratura Manganese plate for lock protection	●	●	●	●
Maniglia in argento (di serie) Silver fittings (standard)	●	●	●	●
Batteria interna tampone Internal buffer battery	●			
Equipaggiamento optional Optional equipment				
Sblocco elettrico Electrical release		●	●	●
Battuta fissa controsoglia Fixed threshold stop	●	●	●	●
Variazioni colori carenatura telaio e battente Colour variation for frame and leaf profiles	●	●	●	●
Batacchio (forme disponibili) Dook knocker (available shapes)	●	●	●	●
Coibentazione lana di roccia Rock wool insulation	●	●	●	●
Maniglia in Ottone resista - Cromo satinato Resista brass fittings - Satin chrome	●	●	●	●
Cromo lucido - Bianco - Nero - Ottone Polished chrome - White - Black - Brass	●	●	●	●

* Non disponibile per versione Door pass

* Not available for the Door pass version



AVVERTENZE:

I colori dei rivestimenti potrebbero risultare alterati nella riproduzione a stampa. Dierre S.p.A. si riserva il diritto di modificare in qualsiasi momento, anche senza preavviso, le caratteristiche dei prodotti illustrati nel presente catalogo.

WARNING:

The colours of the panelling may be altered in the print reproduction. Dierre S.p.A. hold the right to modify at any time - even with no prior notice - the features of the products illustrated in the present catalogue.

